

PJWU-101B

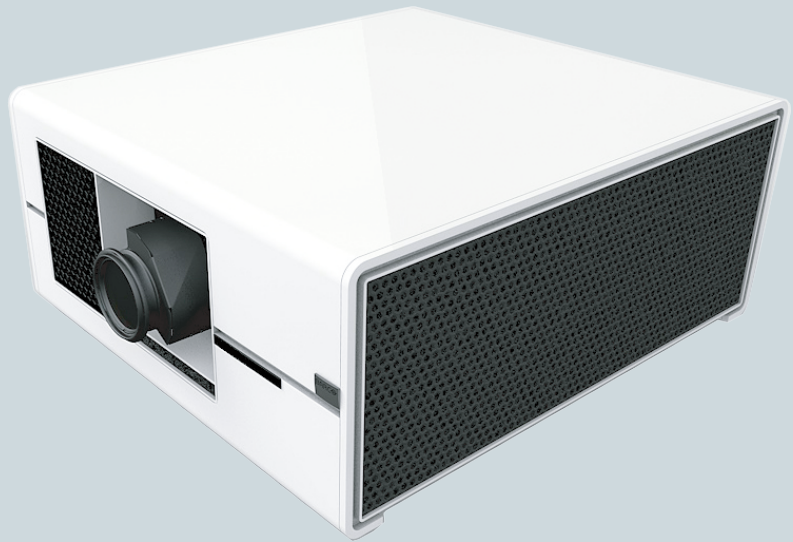

User manual

Barco nv Projection Division

Noordlaan 5, B-8520 Kurne

Phone: +32 56.36.82.11

Fax: +32 56.36.883.86

Support: www.barco.com/esupport

Visit us at the web: www.barco.com

Printed in China

Changes

Barco provides this manual 'as is' without warranty of any kind, either expressed or implied, including but not limited to the implied warranties or merchantability and fitness for a particular purpose. Barco may make improvements and/or changes to the product(s) and/or the program(s) described in this publication at any time without notice.

This publication could contain technical inaccuracies or typographical errors. Changes are periodically made to the information in this publication; these changes are incorporated in new editions of this publication.

The latest edition of Barco manuals can be downloaded from the Barco web site www.barco.com or from the secured Barco web site <https://my.barco.com>.

Copyright ©

All rights reserved. No part of this document may be copied, reproduced or translated. It shall not otherwise be recorded, transmitted or stored in a retrieval system without the prior written consent of Barco.

EN55022/CISPR22 Class A ITE (Information Technology Equipment)

Class A ITE is a category of all other ITE which satisfies the class A ITE limits but not the class B ITE limits. Such equipment should not be restricted in its sale but the following warning shall be included in the instructions for use:

Warning : This is a class A product. In a domestic environment this product may cause radio interference in which case the user may be required to take adequate measures.

Federal Communications Commission (FCC Statement)

This equipment has been tested and found to comply with the limits for a class A digital device, pursuant to Part 15 of the FCC rules. These limits are designed to provide reasonable protection against harmful interference when the equipment is operated in a commercial environment. This equipment generates, uses, and can radiate radio frequency energy and, if not installed and used in accordance with the instruction manual, may cause harmful interference to radio communications. Operation of this equipment in a residential area may cause harmful interference, in which case the user will be responsible for correcting any interference at his own expense.

Guarantee and Compensation

Barco provides a guarantee relating to perfect manufacturing as part of the legally stipulated terms of guarantee. On receipt, the purchaser must immediately inspect all delivered goods for damage incurred during transport, as well as for material and manufacturing faults. Barco must be informed immediately in writing of any complaints.

The period of guarantee begins on the date of transfer of risks, in the case of special systems and software on the date of commissioning, at latest 30 days after the transfer of risks. In the event of justified notice of complaint, Barco can repair the fault or provide a replacement at its own discretion within an appropriate period. If this measure proves to be impossible or unsuccessful, the purchaser can demand a reduction in the purchase price or cancellation of the contract. All other claims, in particular those relating to compensation for direct or indirect damage, and also damage attributed to the operation of software as well as to other services provided by Barco, being a component of the system or independent service, will be deemed invalid provided the damage is not proven to be attributed to the absence of properties guaranteed in writing or due to the intent or gross negligence or part of Barco.

If the purchaser or a third party carries out modifications or repairs on goods delivered by Barco, or if the goods are handled incorrectly, in particular if the systems are commissioned operated incorrectly or if, after the transfer of risks, the goods are subject to influences not agreed upon in the contract, all guarantee claims of the purchaser will be rendered invalid. Not included in the guarantee coverage are system failures which are attributed to programs or special electronic circuitry provided by the purchaser, e.g. interfaces. Normal wear as well as normal maintenance are not subject to the guarantee provided by Barco either.

The environmental conditions as well as the servicing and maintenance regulations specified in this manual must be complied with by the customer.

Trademarks

Brand and product names mentioned in this manual may be trademarks, registered trademarks or copyrights of their respective holders. All brand and product names mentioned in this manual serve as comments or examples and are not to be understood as advertising for the products or their manufacturers.

1. SAFETY	1
1.1 General considerations	1
1.2 Important safety instructions	2
2. GENERAL	5
2.1 Installation requirements	5
2.2 Unpacking the projector	6
2.3 Initial inspection	7
2.4 Projector configurations	8
2.5 Projector air inlets and outlets	11
2.6 Installation process overview	11
3. PHYSICAL INSTALLATION	12
3.1 Remote control unit (RCU)	12
3.2 Lenses	14
3.3 Connecting the projector with the power net	17
3.4 Alignment of a table mounted projector	19
3.5 Mounting the Ceiling mount	20
4. PROJECTOR PARTS AND FUNCTIONS	21
4.1 Projector front view	21
4.2 Projector Rear view	21
4.3 Input and Communication	22
4.4 Status lights of LED	24
4.5 Connecting the projector to other devices	25

5. GETTING STARTED	29
5.1 RCU & Local keypad	29
5.2 Remote Control and OSD Lite on Screen	29
5.3 Power on projector	31
5.4 Switching to standby	31
5.5 Power off projector	31
5.6 Range of effective remote control signal reception	32
5.7 Source selection	32
5.8 Changing OSD language	33
5.9 Adjusting the lens by horizontal and vertical lens shift	33
5.10 Introduction the OSD Lite on screen	34
6. ADVANCED OSD MENU	35
6.1 How to activate the Advanced OSD menu	35
6.2 How to navigate in the Advanced menu structure?	36
6.3 Advanced menu memory	36
7. INPUT	37
7.1 Input menu overview	37
7.2 Input Selection	38
7.3 Input Configuration	38
7.4 Input Locking	38
7.5 Auto Power Off	39
7.6 Auto Power ON	39
7.7 No Signal	39
7.8 Auto Image Adjust	39

8. IMAGE	40
8.1 Image menu overview	40
8.2 Contrast	41
8.3 Brightness	41
8.4 Sharpness	42
8.5 Noise Reduction	42
8.6 Color Temperature	42
8.7 Input Balance	43
8.8 Aspect Ratio	45
8.9 Timings	46
8.10 Auto Image	47
9. LAYOUT	48
9.1 Layout menu overview	48
9.2 Zoom	49
9.3 Main Select	49
9.4 PIP Select	50
9.5 PIP Position	50
9.6 PIP	50
10. LAMP	51
10.1 Lamp menu overview	51
10.2 Mode	52
10.3 Lamps	52
10.4 High Altitude Mode	53
10.5 Power	53
10.6 Lamp1 Status	53
10.7 Lamp2 Status	53
10.8 Lamp1 Run Time	53
10.9 Lamp2 Run Time	53
10.10 Lamp Performance	53

11. ALIGNMENT	54
11.1 Alignment menu overview	54
11.2 Adjusting screen orientation	55
11.3 Rear Projection	55
11.4 Ceiling Mode	56
11.5 Lens Control	56
11.6 Keystone	56
11.7 Dynamic Contrast	56
11.8 Gamma	57
11.9 Internal Patterns	57
11.10 Color Space	57
11.11 Lens To Midposition	57
12. CONTROL	58
12.1 Control menu overview	58
12.2 Eco Network Power	59
12.3 Network	59
12.4 Menu Position	60
12.5 Start Up Logo	61
12.6 Start Up Chime	61
12.7 Trigger1 ~2	61
12.8 Auto Source	61
12.9 Language	61
13. SERVICE	62
13.1 Service menu overview	62
13.2 Service message of the projector	63
13.3 Lamp Hour Reset	63
13.4 Blue Only	63
13.5 Factory Reset	63

14. MAINTENANCE	64
14.1 Lamp Replacement	64
14.2 Replace the filter (for inlet <i>Ventilation</i>)	66
14.3 Clean the dust filter(for outlet <i>Ventilation</i>)	69
14.4 Cleaning the lens	69
14.5 Cleaning the exterior of the projector	70
14.6 Simple troubleshooting	70
15. PROJECTOR SPECIFICATION	72
15.1 Specifications	72
15.2 STANDARD SOURCE FILES	73
15.3 Dimension	74
16. ENVIRONMENTAL INFORMATION	75
16.1 Disposal information	75
16.2 Rohs compliance	75
16.3 Production address	77

1. SAFETY

About this chapter

Read this chapter attentively. It contains important information to prevent personal injury while installing and using a PJWU-101B projector. Furthermore, it includes several cautions to prevent damage to the PJWU-101B projector. Ensure that you understand and follow all safety guidelines, safety instructions and warnings mentioned in this chapter before installing your PJWU-101B projector. After this chapter, additional "warnings" and "cautions" are given depending on the installation procedure. Read and follow these "warnings" and "cautions" as well.

1.1 General considerations

When referring in this document to the term "PRESENT SERIES" means that the content is applicable for following Barco products:

- PJWU-101B



WARNING: Ensure you understand and follow all the safety guidelines, safety instructions, warnings and cautions mentioned in this manual.



WARNING: Be aware of suspended loads.



WARNING: Wear a hard hat to reduce the risk of personal injury.



WARNING: Be careful while working with heavy loads.



WARNING: Mind your fingers while working with heavy loads.



CAUTION: High pressure lamp may explode if improperly handled.

General safety instructions

- Before operating this equipment please read this manual thoroughly and retain it for future reference.
- Installation and preliminary adjustments should be performed by qualified Barco personnel or by authorized Barco service dealers.
- All warnings on the projector and in the documentation manuals should be adhered to.
- All instructions for operating and use of this equipment must be followed precisely.
- All local installation codes should be adhered to.

Notice on safety

This equipment is built in accordance with the requirements of the international safety standards IEC60950-1, EN60950-1, UL60950-1 and CAN/CSA C22.2 No.60950-1, which are the safety standards of information technology equipment including electrical business equipment. These safety standards impose important requirements on the use of safety critical components, materials and insulation, in order to protect the user or operator against risk of electric shock and energy hazard and having access to live parts. Safety standards also impose limits to the internal and external temperature rises, radiation levels, mechanical stability and strength, enclosure construction and protection against the risk of fire. Simulated single fault condition testing ensures the safety of the equipment to the user even when the equipment's normal operation fails.

Users definition

Throughout this manual, the term SERVICE PERSONNEL refers to persons having appropriate technical training and experience necessary to be knowledgeable of potential hazards to which they are exposed (including, but not limited to HIGH VOLTAGE ELECTRIC and ELECTRONIC CIRCUITRY and HIGH BRIGHTNESS PROJECTORS) in performing a task, and of measures to minimize the potential risk to themselves or other persons. The term USER and OPERATOR refers to any person other than SERVICE PERSONNEL, AUTHORIZED to operate professional projection systems.

A PJWU-101B projector is intended "FOR PROFESSIONAL USE ONLY" by AUTHORIZED PERSONNEL familiar with potential hazards associated with high voltage, high intensity light beams, ultraviolet exposure and high temperatures generated by the lamp and associated circuits. Only qualified SERVICE PERSONNEL, knowledgeable of such risks, are allowed to perform service functions inside the product enclosure.

1.2 Important safety instructions

To prevent the risk of electrical shock

- This product should be operated from a mono phase AC power source.
- This apparatus must be grounded (earthed) via the supplied 3 conductor AC power cable. If none of the supplied power cables are the correct one, consult your dealer. If you are unable to insert the plug into the outlet, contact your electrician to replace your obsolete outlet. Do not defeat the purpose of the grounding-type plug.
- Do not allow anything to rest on the power cord. Do not locate this product where persons will walk on the cord. To disconnect the cord, pull it out by the plug. Never pull the cord itself.
- Use only the power cord supplied with your device. While appearing to be similar, other power cords have not been safety tested at the factory and may not be used to power the device. For a replacement power cord, contact your dealer.
- Do not operate the projector with a damaged cord. Replace the cord. Do not operate the projector if the projector has been dropped or damaged - until it has been examined and approved for operation by a qualified service technician.
- Position the cord so that it will not be tripped over, pulled, or contact hot surfaces.
- If an extension cord is necessary, a cord with a current rating at least equal to that of the projector should be used. A cord rated for less amperage than the projector may overheat.
- Never push objects of any kind into this product through cabinet slots as they may touch dangerous voltage points or short out parts that could result in a risk of fire or electrical shock.
- Do not expose this projector to rain or moisture.
- Do not immerse or expose this projector in water or other liquids.
- Do not spill liquid of any kind on this projector.
- Should any liquid or solid object fall into the cabinet, unplug the set and have it checked by qualified service personnel before resuming operations.
- Do not disassemble this projector, always take it to an authorized trained service person when service or repair work is required.
- Do not use an accessory attachment which is not recommended by the manufacturer.
- Lightning - For added protection for this video product during a lightning storm, or when it is left unattended and unused for long periods of time, unplug it from the wall outlet. This will prevent damage to the device due to lightning and AC power-line surges.

To prevent personal injury

- Isolate electrically before replacing the lamp or lamp house. Caution: Hot lamp (house).
- Caution: High pressure lamp may explode if improperly handled. Refer servicing to qualified service personnel.
- To prevent injury and physical damage, always read this manual and all labels on the system before inserting the lamp casing, connecting to the wall outlet or adjusting the projector.
- To prevent injury, take note of the weight of the projector. Minimum 2 persons are needed to carry the projector.
- To prevent injury, ensure that the lens and all covers are correctly installed. See installation procedures.
- Warning: high intensity light beam. NEVER look into the lens ! High luminance could result in damage to the eye.
- **Warning: extremely high brightness lamps:** This projector uses extremely high brightness lamps. Never attempt to look directly into the lens or at the lamp. If the projection distance is less than 6 meter, any person needs to be at least 4 meters away from the projected image. Avoid close range reflection of the projected image on any reflecting surface (such as glass, metal, ...) . When operating the projector, we strongly recommend wearing suitable safety glasses.
- Before attempting to remove any of the projector's covers, you must turn off the projector and disconnect from the wall outlet.
- When required to switch off the projector, to access parts inside, always disconnect the power cord from the power net.
- The power input at the projector side is considered as the disconnect device. When required to switch off the projector, to access parts inside, always disconnect the power cord at the projector side. In case the power input at the projector side is not accessible (e.g. ceiling mount), the socket outlet supplying the projector shall be installed nearby the projector and be easily accessible, or a readily accessible general disconnect device shall be incorporated in the fixed wiring.
- Do not place this equipment on an unstable cart, stand, or table. The product may fall, causing serious damage to it

and possible injury to the user.

- It is hazardous to operate without lens or shield. Lenses, shields or ultra violet screens shall be changed if they have become visibly damaged to such an extent that their effectiveness is impaired. For example by cracks or deep scratches.
- **Warning: Protection from ultraviolet radiation:** Do not look directly in the light beam. The lamp contained in this product is an intense source of light and heat. One component of the light emitted from this lamp is ultraviolet light. Potential eye and skin hazards are present when the lamp is energized due to ultraviolet radiation. Avoid unnecessary exposure. Protect yourself and your employees by making them aware of the hazards and how to protect themselves. Protecting the skin can be accomplished by wearing tightly woven garments and gloves. Protecting the eyes from UV can be accomplished by wearing safety glasses that are designed to provide UV protection. In addition to the UV, the visible light from the lamp is intense and should also be considered when choosing protective eye wear.
- **Exposure to UV radiation:** Some medications are known to make individuals extra sensitive to UV radiation. The American Conference of Governmental Industrial Hygienists (ACGIH) recommends occupational UV exposure for an-8 hour day to be less than 0,1 micro-watts per square centimeters of effective UV radiation. An evaluation of the workplace is advised to assure employees are not exposed to cumulative radiation levels exceeding these government guidelines. The exposer of this UV radiation is allowed for only 1 hour per day for maintenance and service persons.
- **Mercury Vapor Warnings:** Keep the following warnings in mind when using the projector. The lamp used in the projector contains mercury. In case of a lamp rupture, explosion there will be a mercury vapor emission. In order to minimize the potential risk of inhaling mercury vapors:
 - Ensure the projector is installed only in ventilated rooms.
 - Replace the lamp module before the end of its operational life.
 - Promptly ventilate the room after a lamp rupture, explosion has occurred, evacuate the room (particularly in case of a pregnant woman).
 - Seek medical attention if unusual health conditions occur after a lamp rupture, explosion, such as headache, fatigue, shortness of breath, chest-tightening coughing or nausea.

To prevent fire hazard

- Do not place flammable or combustible materials near the projector!
- Barco large screen projection products are designed and manufactured to meet the most stringent safety regulations. This projector radiates heat on its external surfaces and from ventilation ducts during normal operation, which is both normal and safe. Exposing flammable or combustible materials into close proximity of this projector could result in the spontaneous ignition of that material, resulting in a fire. For this reason, it is absolutely necessary to leave an "exclusion zone" around all external surfaces of the projector whereby no flammable or combustible materials are present. The exclusion zone must be not less than 50 cm (20") for all DLP projectors. The exclusion zone on the lens side must be at least 5 m. Do not cover the projector or the lens with any material while the projector is in operation. Keep flammable and combustible materials away from the projector at all times. Mount the projector in a well ventilated area away from sources of ignition and out of direct sun light. Never expose the projector to rain or moisture. In the event of fire, use sand, CO₂ or dry powder fire extinguishers. Never use water on an electrical fire. Always have service performed on this projector by authorized Barco service personnel. Always insist on genuine Barco replacement parts. Never use non-Barco replacement parts as they may degrade the safety of this projector.
- Slots and openings in this equipment are provided for ventilation. To ensure reliable operation of the projector and to protect it from overheating, these openings must not be blocked or covered. The openings should never be blocked by placing the projector too close to walls, or other similar surface. This projector should never be placed near or over a radiator or heat register. This projector should not be placed in a built-in installation or enclosure unless proper ventilation is provided.
- Projection rooms must be well ventilated or cooled in order to avoid build up of heat.
- Let the projector cool down completely before storing. Remove cord from the projector when storing.
- Heat sensitive materials should not be placed in the path of the exhausted air or on the lamp house.

To prevent projector damage

- This projector has been designed for use with a specific lamp (house) type. See installation instructions for its correct type.
- The air filters of the projector must be cleaned or replaced on regular base (a "clean" booth would be monthly-minimum).Neglecting this could result in disrupting the air flow inside the projector, causing overheating. Overheating may lead to the projector shutting down during operation.
- The projector must always be installed in a manner which ensures free flow of air into its air inlets and unimpeded evacuation of the hot air from its cooling system.
- In order to ensure that correct airflow is maintained, and that the projector complies with Electromagnetic Compatibility (EMC)requirements, it should always be operated with all of it's covers in place.
- Slots and openings in the cabinet are provided for ventilation. To ensure reliable operation of the product and to protect it from overheating, these openings must not be blocked or covered. The openings should never be blocked by placing the product on a bed, sofa, rug, or other similar surface. This product should never be placed near or over a radiator or heat register. The device should not be placed in a built-in installation or enclosure unless proper ventilation is provided.

- Ensure that nothing can be spilled on, or dropped inside the projector. If this does happen, switch off and unplug the mains supply immediately. Do not operate the projector again until it has been checked by qualified service personnel.
- Do not block the projector cooling fans or free air movement around the projector. Loose papers or other objects may not be nearer to the projector than 30 cm (12") on any side.
- Do not use this equipment near water.
- **Special care for Laser Beams:**Special care should be used when DLP projectors are used in the same room as high power laser equipment. Direct or indirect hitting of a laser beam on to the lens can severely damage the Digital Mirror Devices TM in which case there is a loss of warranty.
- Never place the projector in direct sun light. Sun light on the lens can severely damage the Digital Mirror Devices TM in which case there is a loss of warranty.
- Save the original shipping carton and packing material. They will come in handy if you ever have to ship your equipment. For maximum protection, repack your set as it was originally packed at the factory.
- Unplug this product from the wall outlet before cleaning. Do not use liquid cleaners or aerosol cleaners. Use a damp cloth for cleaning. Never use strong solvents, such as thinner or benzine, or abrasive cleaners, since these will damage the cabinet. Stubborn stains may be removed with a cloth lightly dampened with mild detergent solution.
- To ensure the highest optical performance and resolution, the projection lenses are specially treated with an anti-reflective coating, therefore, avoid touching the lens. To remove dust on the lens, use a soft dry cloth. Do not use a damp cloth, detergent solution, or thinner.
- Rated maximum ambient temperature, $t_a = 40\text{ }^\circ\text{C}$ (104 $^\circ\text{F}$).
- The lamp house shall be replaced if it has become damaged or thermally deformed.

On servicing

- Do not attempt to service this product yourself, as opening or removing covers may expose you to dangerous voltage potentials and risk of electric shock.
- Refer all servicing to qualified service personnel.
- Attempts to alter the factory-set internal controls or to change other control settings not specially discussed in this manual can lead to permanent damage to the projector and cancellation of the warranty.
- Unplug this product from the wall outlet and refer servicing to qualified service technicians under the following conditions:
 - When the power cord or plug is damaged or frayed.
 - If liquid has been spilled into the equipment.
 - If the product has been exposed to rain or water.
 - If the product does not operate normally when the operating instructions are followed. Adjust only those controls that are covered by the operating instructions since improper adjustment of the other controls may result in damage and will often require extensive work by a qualified technician to restore the product to normal operation.
 - If the product has been dropped or the cabinet has been damaged.
 - If the product exhibits a distinct change in performance, indicating a need for service.
- Replacement parts: When replacement parts are required, be sure the service technician has used original Barco replacement parts or authorized replacement parts which have the same characteristics as the Barco original part. Unauthorized substitutions may result in degraded performance and reliability, fire, electric shock or other hazards. Unauthorized substitutions may void warranty.
- Safety check: Upon completion of any service or repairs to this projector, ask the service technician to perform safety checks to determine that the product is in proper operating condition.
- Possible explosion hazard: Always keep in mind the caution below:



CAUTION: Do not touch a lamp during operation and right after it is turned off as it is extremely hot. Lamp contains mercury. It's brokeage might cause mercury or broken glass pieces to folow out of lamp housing. To avoid exposure the risk of mercury poisoning. Don't drop, hit, force or scratch while handing a lamp.

To prevent battery explosion

- Danger of explosion if battery is incorrectly installed.
- Replace only with the same or equivalent type recommended by the manufacturer.
- For disposal of used batteries, always consult federal, state, local and provincial hazardous waste disposal rules and regulations to ensure proper disposal.
- Battery type: size-AAA (R03). Only Carbon-Zinc or Alkaline-Manganese Dioxide type batteries should be used.

2. GENERAL

About this chapter

Read this chapter before installing your PJWU-101B projector. It contains important information concerning installation requirements for the PJWU-101B projector, such as minimum and maximum allowed ambient temperature, humidity conditions, required safety area around the installed projector, required power net, etc.

Furthermore, careful consideration of things such as image size, ambient light level, projector placement and type of screen to use are critical to the optimum use of the projection system.

Overview

- Installation requirements
- Unpacking the projector
- Initial inspection
- Projector configurations
- Projector air inlets and outlets
- Installation process overview



WARNING: Barco provides a guarantee relating to perfect manufacturing as part of the legally stipulated terms of guarantee. Observing the specification mentioned in this chapter is critical for projector performance. Neglecting this can result in loss of warranty.

2.1 Installation requirements

Environment conditions

Table below summarizes the physical environment in which the PJWU-101B projector may be safely operated or stored.

Environment	Operating	Non-Operating
Ambient Temperature	0 °C (32 °F) to 40 °C (104 °F)	-20°C (-4°F) to 60°C (140°F)
Humidity	up to 90% RH Non-condensed	up to 90% RH Non-condensed
Altitude	-60 (-197Ft) to 3000m (9843Ft)	-60 (-197Ft) to 10000m (32810Ft)



Let the projector acclimatize after unpacking. Neglecting this may result in a startup failure of the Light Processor Unit.

Cooling requirements

The projector is fan cooled and must be installed with sufficient space around the projector head, minimum 30 cm (12 inch) to ensure sufficient air flow. It should be used in an area where the ambient temperature, as measured at the projector air inlet, does not exceed +40°C (+104°F).

Clean air environment

A projector must always be mounted in a manner which ensures the free flow of clean air into the projectors ventilation inlets. For installations in environments where the projector is subject to airborne contaminants such as that produced by smoke machines or similar (these deposit a thin layer of greasy residue upon the projectors internal optics and imaging electronic surfaces, degrading performance), then it is highly advisable and desirable to have this contamination removed prior to it reaching the projectors clean air supply. Devices or structures to extract or shield contaminated air well away from the projector are a prerequisite, if this is not a feasible solution then measures to relocate the projector to a clean air environment should be considered.

Only ever use the manufacturer's recommended cleaning kit which has been specifically designed for cleaning optical parts, never use industrial strength cleaners on the projector's optics as these will degrade optical coatings and damage sensitive optoelectronics components. Failure to take suitable precautions to protect the projector from the effects of persistent and prolonged air contaminants will culminate in extensive and irreversible ingrained optical damage. At this stage cleaning of the internal optical units will be noneffective and impracticable. Damage of this nature is under no circumstances covered under the manufacturer's warranty and may deem the warranty null and void. In such a case the client shall be held solely responsible for all costs incurred during any repair. It is the clients responsibility to ensure at all times that the projector is protected from the harmful effects of hostile airborne particles in the environment of the projector. The manufacturer reserves the right to refuse repair if a projector has been subject to knowingly neglect, abandon or improper use.

Main Power requirements

The PJWU-101B projector operates from a nominal mono phase power net with a separate earth ground PE.

Projector	Power requirements
PJWU-101B	AC INPUT 100-130V 11.6A 50/60Hz AC INPUT 200-240V 5.6A 50/60Hz

The power cord required to connect the projector with the power net is delivered with the projector.

Projector weight

Do not underestimate the weight of the PJWU-101B projector. The projector weights about ± 33 kg (± 72.75 lb.) without lens. Be sure that the pedestal or ceiling mount on which the projector has to be installed is capable of handling five (5) times the complete load of the system.

2.2 Unpacking the projector

1. Remove the tape around the carton box, then open the box.

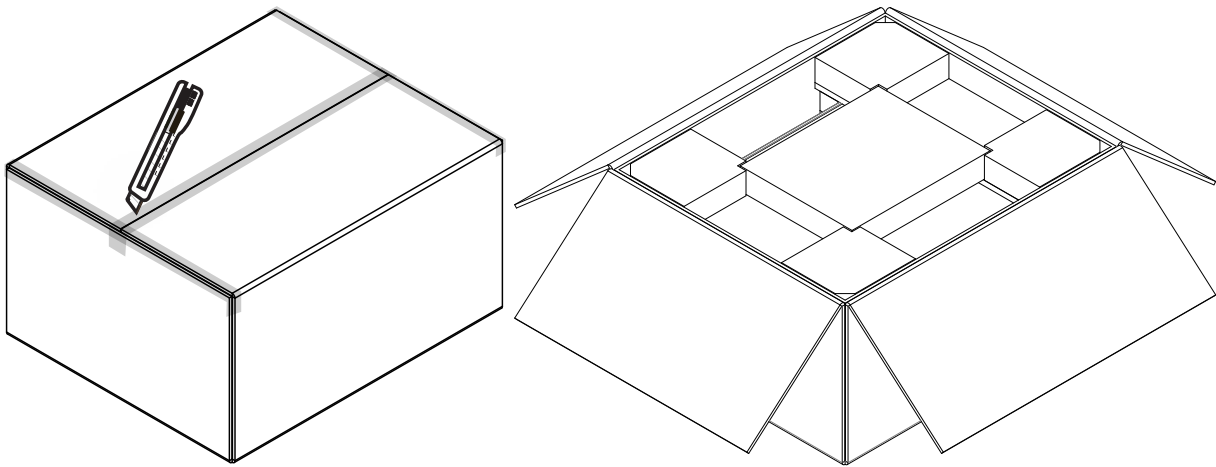

2. Take out the foam upper the projector.

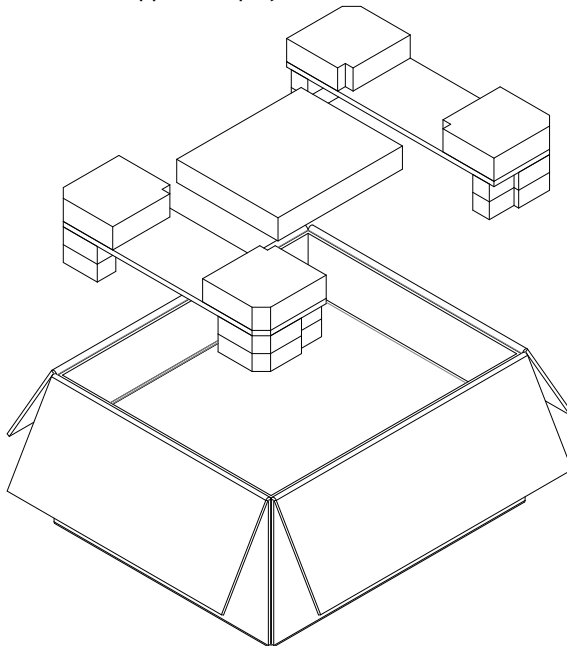

3. Take out the projector.

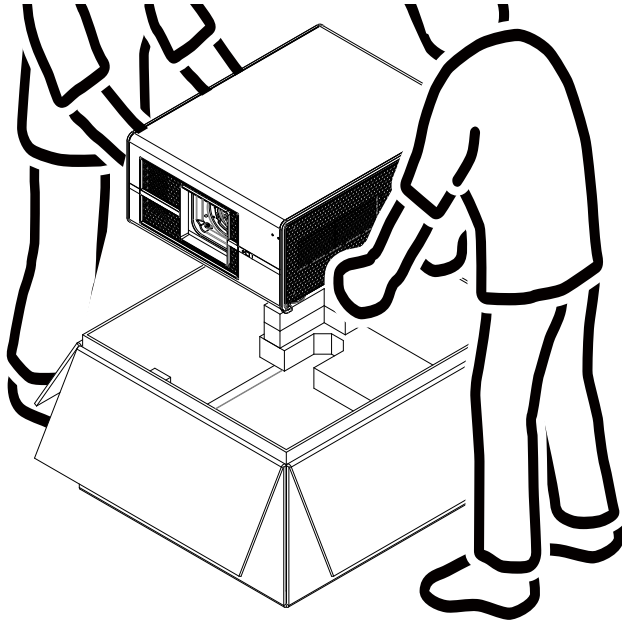

After unpacking let the projector acclimatizes to a room temperature higher than 10°C (50°F) and lower than 40°C (104°F). Neglecting this may result in a start up failure of the Light Processor Unit.



Save the original shipping carton and packing material, they will be necessary if you ever have to ship your projector. For maximum protection, repack your projector as it was originally packed at the factory.



The lens is delivered in a separate box.

2.3 Initial inspection

General

Before shipment, the projector was inspected and found to be free of mechanical and electrical defects. As soon as the projector is unpacked, inspect for any damage that may have occurred in transit. Save all packing material until the inspection is completed. If damage is found, file claim with carrier immediately. The Barco Sales and Service office should be notified as soon as possible.

Box content

After unpacking the projector it is recommended to check if all following items where included:

- Three power cords
- One DVI-D to HDMI cable
- CD (Contents has this installation manual)
- One Safety manual
- One remote control unit (RCU)
- Two AAA size batteries for the RCU



Two lamps are mounted inside the lamp house at delivery. The projector lenses are not included in the package of the projector.

Mechanical check

This check should confirm that there are no broken knobs or connectors, that the cabinet and panel surfaces are free of dents and scratches, and that the operating panel is not scratched or cracked. The Barco Sales and Service office should be notified as soon as possible if this is not the case.

2.4 Projector configurations

The different configurations

Depending on the installation the projector can be mounted in different ways, the different configurations are:

1. Front / Table (F/T)
2. Front / Ceiling (F/C) (upside down)
3. Front / Ceiling (F/C) (table position)
4. Rear / Table (R/T)
5. Rear / Ceiling (R/C) (upside down)
6. Rear / Ceiling (R/C) (table position)

Front projection

The projector is installed, either in a table mount or ceiling mount configuration, at the same side of the screen as the audience.

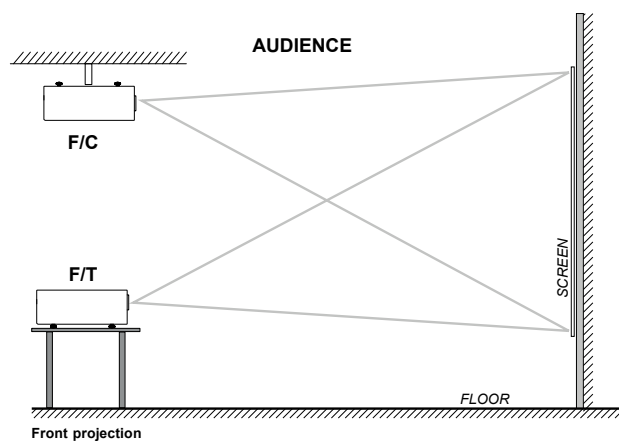

Rear projection

The projector is installed, either in a table mount or ceiling mount configuration, at the other side of the screen opposite the audience.

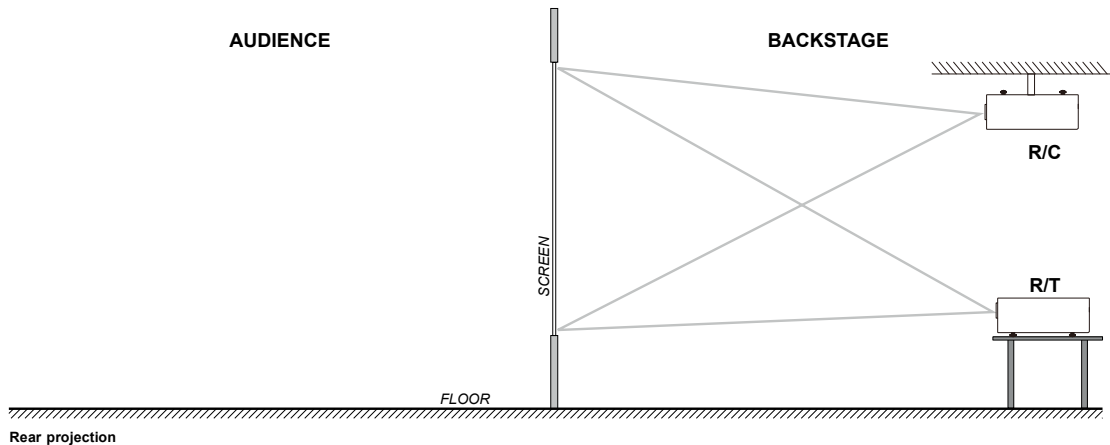

Positioning the projector

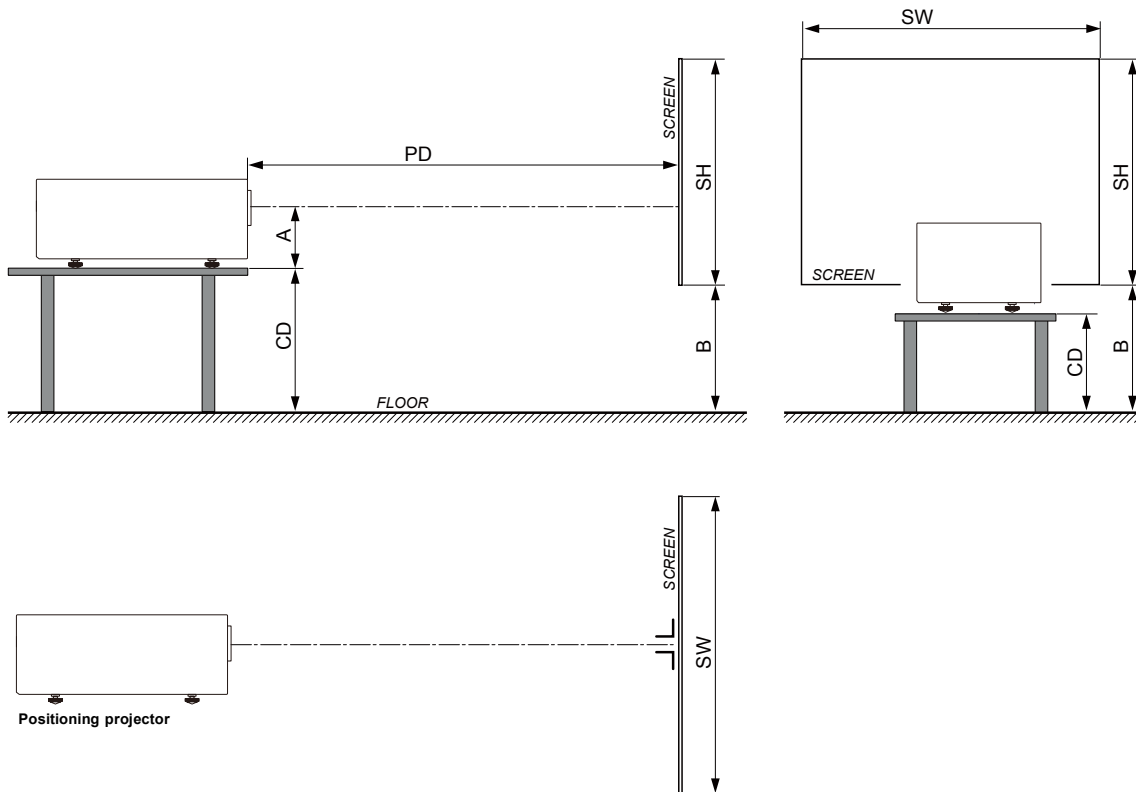

The projector should be installed at right angles (horizontally and vertically) to the screen at a distance PD. Note the distance (A) between lens centre and table surface is slightly variable. This distance (A) is nominal 14 cm in case all feet are turned in completely and the vertical lens shift is set to zero (0).

On axis / off axis projection

The position of the projector with reference to the screen may also be different depending on the installation. Basically the projector can be positioned in On-Axis or Off-Axis configuration. On-Axis configuration means that the projector is positioned so as to have the centre of the lens coinciding with the centre of the screen. Off-Axis projection is obtained by shifting the lens up, down, left or right. Several parameters can be calculated determining the position in any installation.

Formula to calculate the distance CD for On-Axis projection: $CD = SH/2 + B - A$

Shift range

The lens can be shifted with respect to the DMD (P) which result in a shifted image on the screen (Off-Axis). A 100% shift means that the centre point of the projected image is shifted by half the screen size. In other words, the centre point of the projected image falls together with the outline of the image in an On-Axis projection. Due to mechanical and optical limitations it's recommended to keep the shift values within the field of view (F) as illustrated below. Within these shift ranges the projector and lens perform excellently. Configuring the projector outside these shift ranges will result in a slight decline of image quality.

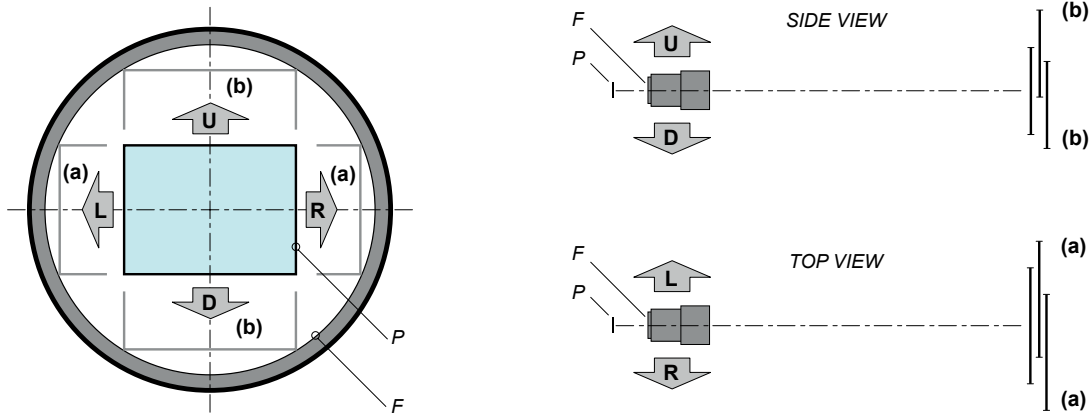

Vertical and horizontal shift range

P DMD.
F Field of view.

No.	Barco nr	Throw Ratio	Horizontal(a) (100%=half the screen width)	Vertical(b) (100%=half the screen height)
1	R9832762	2.4~4.0:1	±30%	±100%
2	R9832760	1.85~2.4:1	±30%	±100%
3	R9832761	1.56~1.85:1	±30%	±100%
4	R9832763	0.84~1.03:1	±25%	±75%



It is mechanical possible to shift outside the recommended field of view, but it will result in a decline of image quality depending on the used lens and the zoom position of the used lens. Furthermore, shifting too much in both directions will result in a blurred image corner.



Best image quality is projected in the On-Axis configuration.

Horizontal and vertical projector tilt ranges

Avoid to reduce the usage of lamp life. Suggest the projector rotated and mounted vertical angle not > ±15°.

Side to side tilt, however, must not exceed ±10°. This limit ensures that the lamp in the projector operates properly and safely.

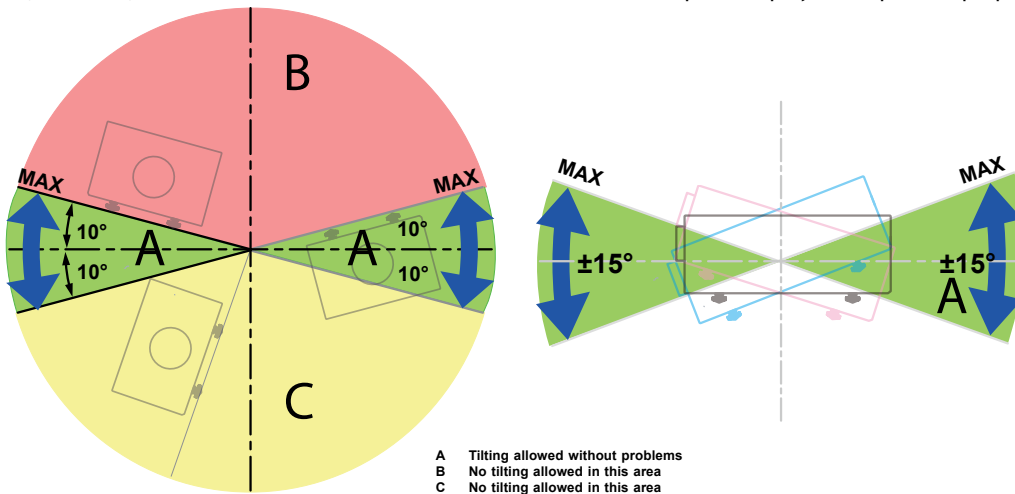

A Tilting allowed without problems
B No tilting allowed in this area
C No tilting allowed in this area

2.5 Projector air inlets and outlets

Ventilation inlet:

The internal cooling fan draws cool air from the ventilation inlet into the projector.

Ventilation outlet:

The hot air generated inside the projector is dispersed through the ventilation slot. Make sure the ventilation slot is free from obstruction.

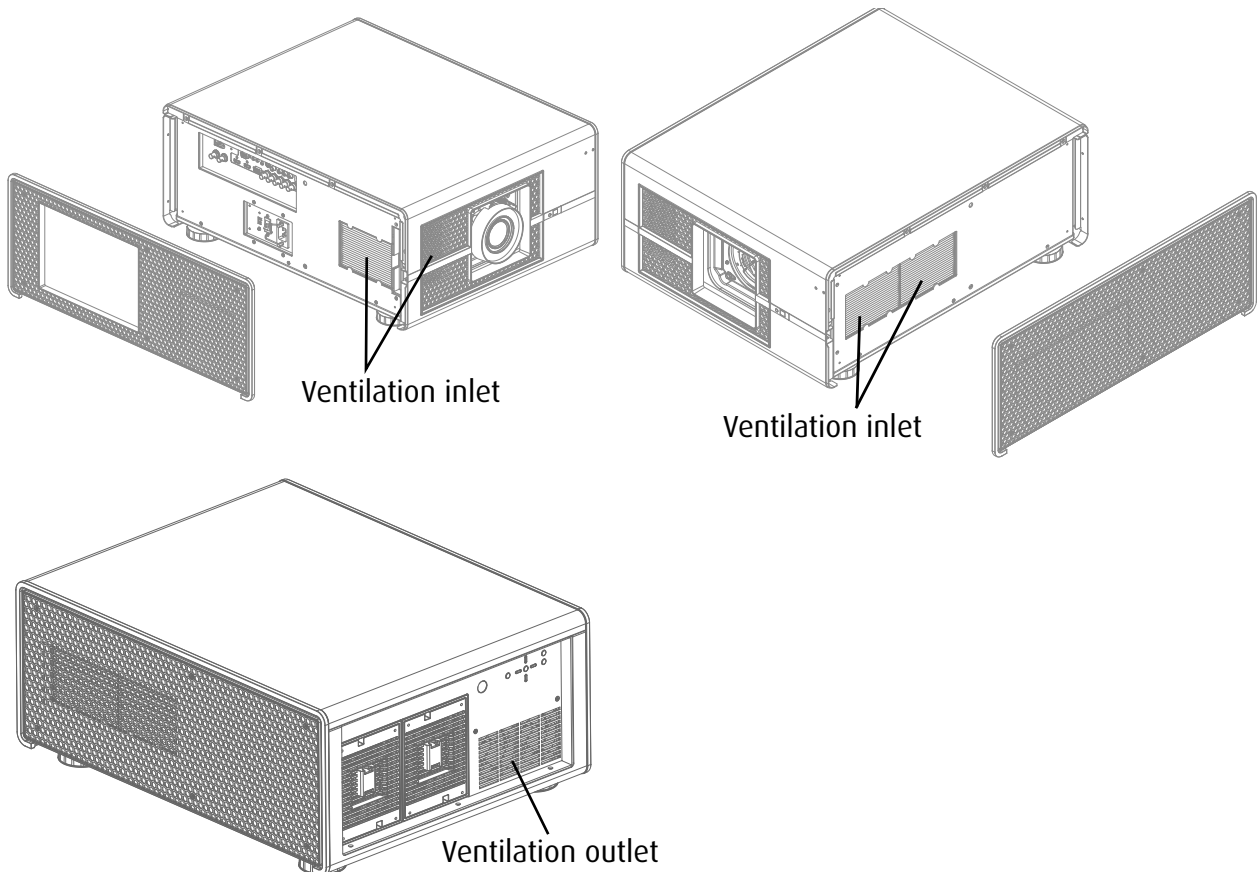

2.6 Installation process overview

Quick setup

The following steps describe briefly how to setup your PJWU-101B projector in a table mount front projection. Note that each step refers to a corresponding procedure, which is more detailed and illustrated.

1. Install the batteries of the remote control. See [page 12: 3.1 Remote control unit \(RCU\)](#)
2. Place the projector on a solid table in front of the screen at the expected throw distance. Adjust the feet to ensure that the projector is installed at right angles (horizontally and vertically) with the screen. See [page 19: 3.4 Alignment of a table mounted projector](#) and [page 33: 5.9 Adjusting the lens by horizontal and vertical lens shift](#)
3. Connect the projector with the local power net. See [page 17: 3.3 Connecting the projector with the power net](#)
4. Select and install an appropriate lens, which covers the throw ratio (= screen size / projector screen distance). See [page 9: Positioning the projector](#)
5. Switch ON the projector. See [page 17: 3.3 Connecting the projector with the power net](#)
6. Connect your source to the appropriate input module. See [page 22: 4.3 Input and Communication](#)
7. Zoom and shift the lens until the image is properly projected on the screen, Do this by using the "ZOOM" and "FOCUS" key on the remote control unit or on the local keypad. If necessary, level the projector from side to side by turning the adjustable feet in or out. See [page 15: Lens zoom](#).

3. PHYSICAL INSTALLATION

About this projector

This chapter describes how the mechanical set up of the projector has to be done and how to realize the electrical connections.

Overview

- Remote control unit (RCU)
- Lenses
- Connecting the projector with the power net
- Alignment of a table mounted projector
- Mounting the ceiling mount

3.1 Remote control unit (RCU)

Introduction

Remove the cover by sliding it in the direction indicated by the arrow.

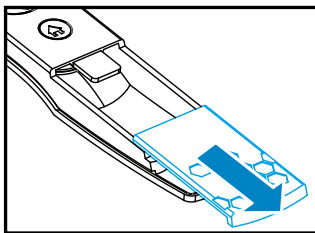

Insert two new AAA batteries (observe the polarity).

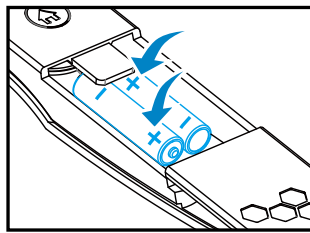

Replace the cover.

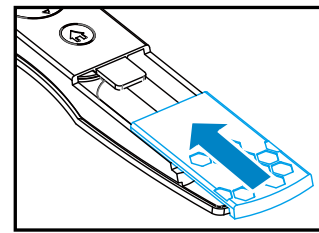

Notes for the Remote control unit

- Be sure to insert the batteries in the corresponding orientations to match the polarities.
- Do not mix new batteries with used batteries as it would shorten the life of new batteries or cause leakage.
- Only used AAA batteries as instructed; do not attempt to insert different types of batteries into the remote control.
- battery type R03. Only Carbon-Zinc or Alkaline-Manganese Dioxide type batteries should be used.
- If the remote is going to be unused for long periods of time, be sure to remove the batteries to prevent leakage, which could damage the remote control.
- The liquid contents in the batteries is harmful to the skin; do not touch the leakage with your bare hands directly. When installing fresh batteries, be sure to clean up the leakage thoroughly.
- Under most circumstances, you only need to point the remote control towards the screen and the IR signal would be reflected off the screen and picked up by the IR sensor on the projector. But under specific circumstances, the projector may fail to receive signals from the remote control due to environmental factors. When this happens, orient the remote control at the projector and try again.
- If the range of effective remote control signal reception decreases or if the remote control stops working, replace the batteries.
- If the infrared receiver is exposed to fluorescent lamp or strong sunlight, the remote control may not operate normally.
- Refer to the regulations enforced by your local government on the disposal of used batteries; improper disposal could damage the environment.

Remote Control overview

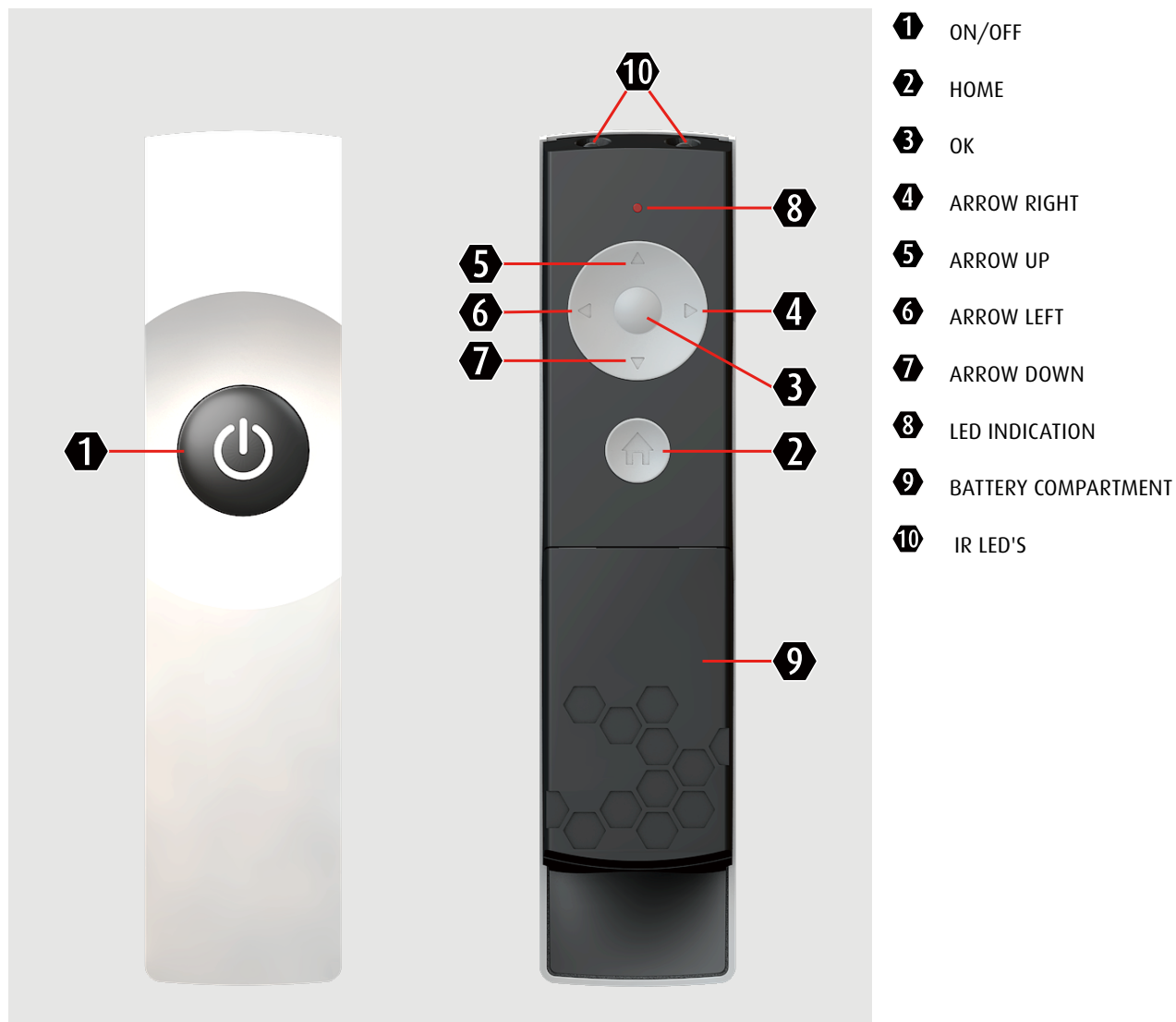

- ❶ ON/OFF
- ❷ HOME
- ❸ OK
- ❹ ARROW RIGHT
- ❺ ARROW UP
- ❻ ARROW LEFT
- ❼ ARROW DOWN
- ❽ LED INDICATION
- ❾ BATTERY COMPARTMENT
- ❿ IR LED'S

Basic Remote Command result	RCU Lite action	
start the projector	press "on/off"	❶
turn off the projector	press "on/off"	❶ > ❶
show main menu on screen	press "home"	❷
move through menu	press "arrow keys"	❷, ❺, ❹, ❻
select button	press "ok"	❸
select and return to previous menu	press "ok"	❸
return to previous menu without selecting	press "home"	❷
clear OSD Lite of screen	press "home"	❷

3.2 Lenses

Available lenses for the PJWU-101B projector projector

- R9832760 : J lens (1,85-2,4 : 1) - Standard Lens
- R9832761 : J lens (1,56-1,86 : 1) - Short Throw Lens
- R9832762 : J lens (2,4-4,0 : 1) - Longer Zoom lens
- R9832763 : J lens (0,84-1,03 : 1) - Extreme Wide Angle Lens



Projection lenses are optional accessories. Please contact your local dealer to acquire the projection lens that suits your need most.

How to install the lens

1. Follow below image to install the lens.

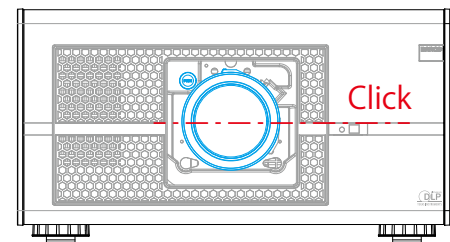
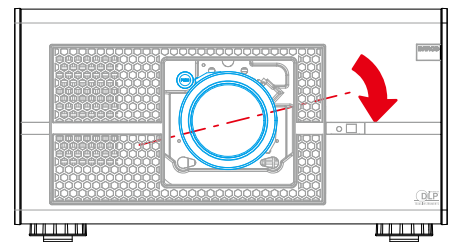
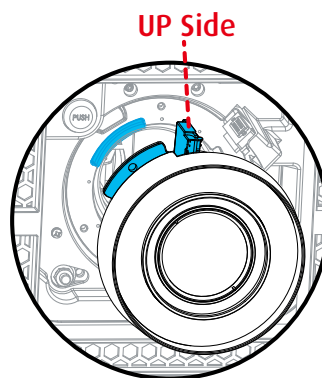
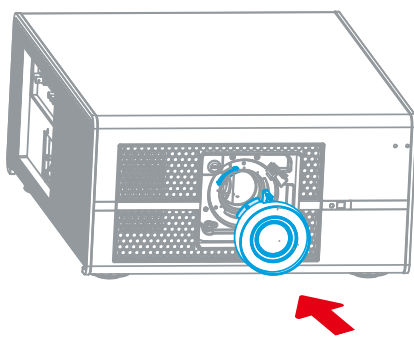

 Carefully align the connectors while installing the lens.

How to remove the lens

1. Press and hold the release button

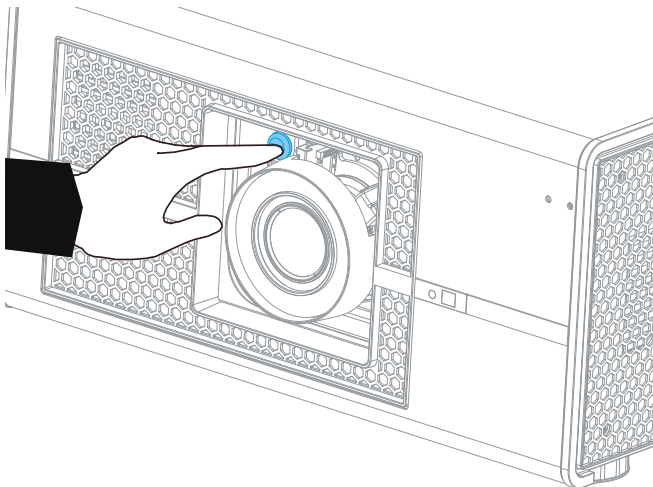

2. Counterclockwise rotate the lens to the end then you can follow the forward direction to remove the lens.

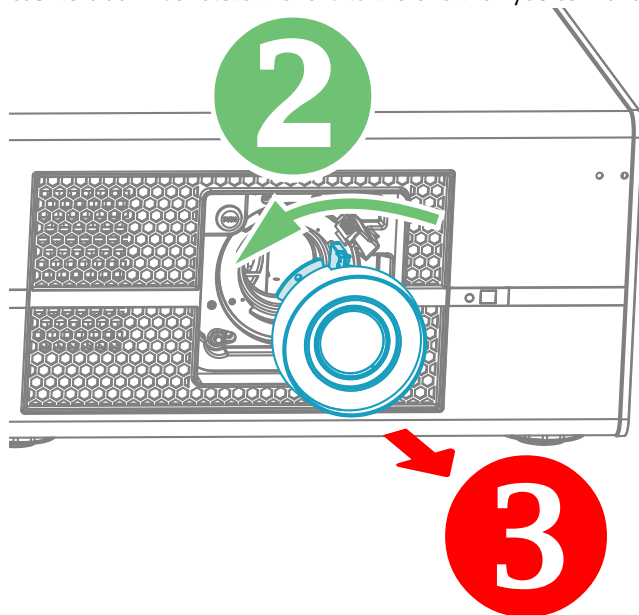



CAUTION: Never transport the projector with a Lens mounted in the Lens Holder. Always remove the Lens before transporting the projector. Neglecting this can damage the Lens Holder and Prism.





It's recommended to place the Lens caps of the original Lens packaging, back on both sides of the removed Lens to protect the optics of the Lens.

Lens focus

Press the button  on the remote control or **HOME** on the projector panel, Choose OSD -> LENS FOCUS , then use the   buttons to adjust the lens' focus (clarity).



Lens zoom

Press the button  on the remote control or **HOME** on the projector panel, Choose OSD -> LENS ZOOM , then use the   buttons to adjust the size of the image that is projected onto the screen.

Original image size



Zoom out



Zoom in



Lens Shift

In addition to using the adjustable feet to adjust projection angle, you can also use the Lens Shift function to adjust the projected image.

- Moving the lens vertically
The distance of vertical lens movement is +100% , -100% of half the screen height in both directions. For instance, if you are using a 80" × 50" screen, you will be able to move the image upwards no more than 25" or downwards no more than 25".

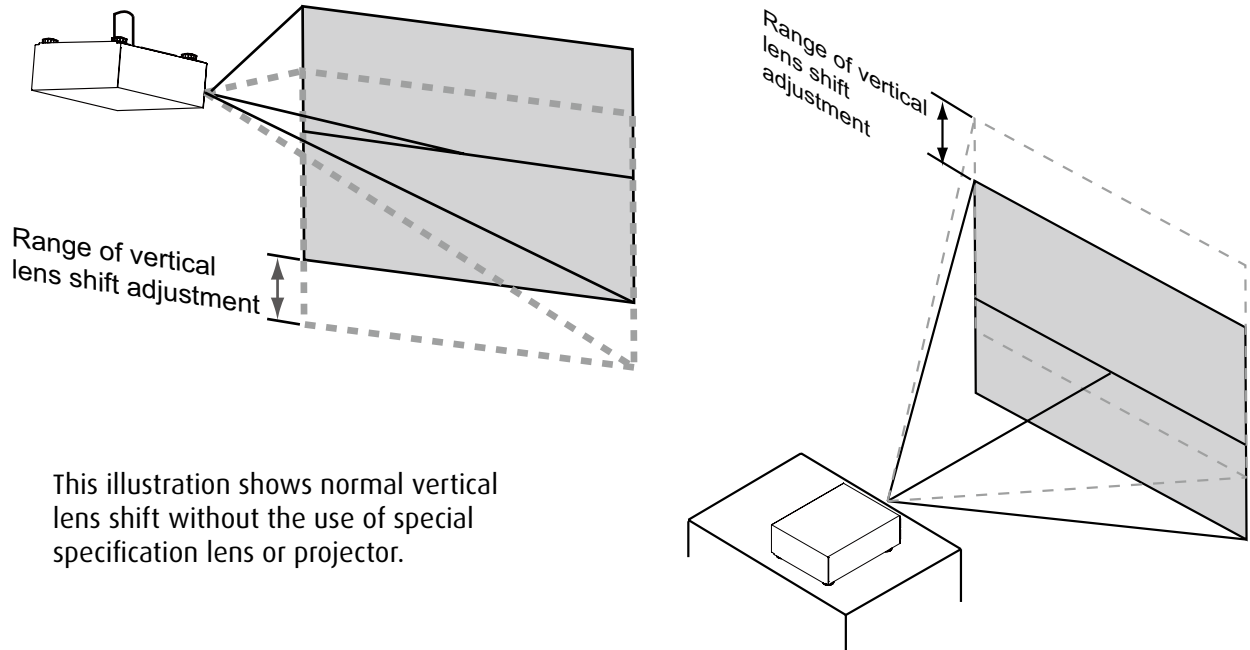

This illustration shows normal vertical lens shift without the use of special specification lens or projector.



Please make sure the center of lens is rectangular to the center of the screen.

- Moving the lens horizontally
The distance of horizontal lens movement is 30% of half the screen width in both directions. For instance, if you are using a 80" × 50" screen, you will be able to move the image left or right by no more than 12".

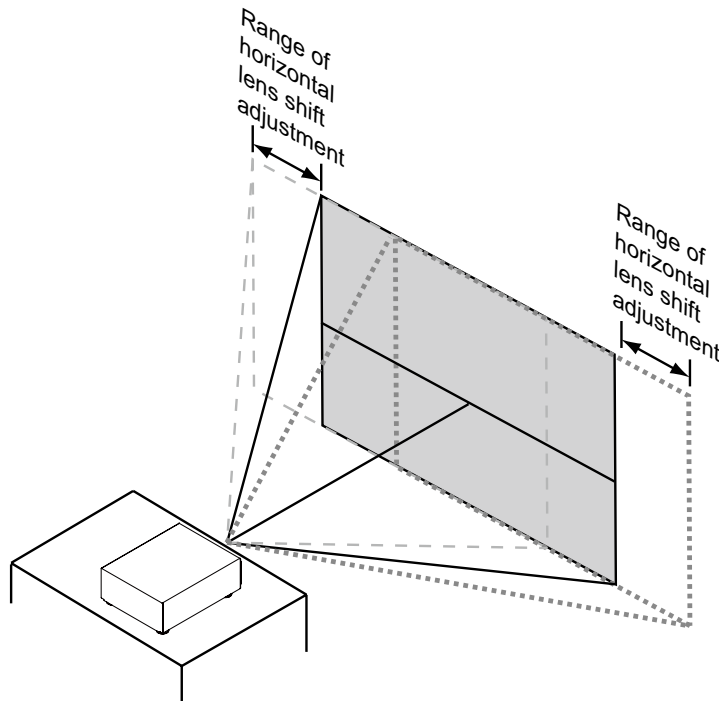

This illustration shows normal horizontal lens shift without the use of special specification lens or projector.

3.3 Connecting the projector with the power net



CAUTION: Use only the power cord provided with the projector.

1. Select correct voltage
2. Ensure that the power switch stands in the '0' (OFF) position .
3. Connect the female side of the power cord with the power input socket of the projector .
4. Secure the power plug by locking the plug holder clamp.

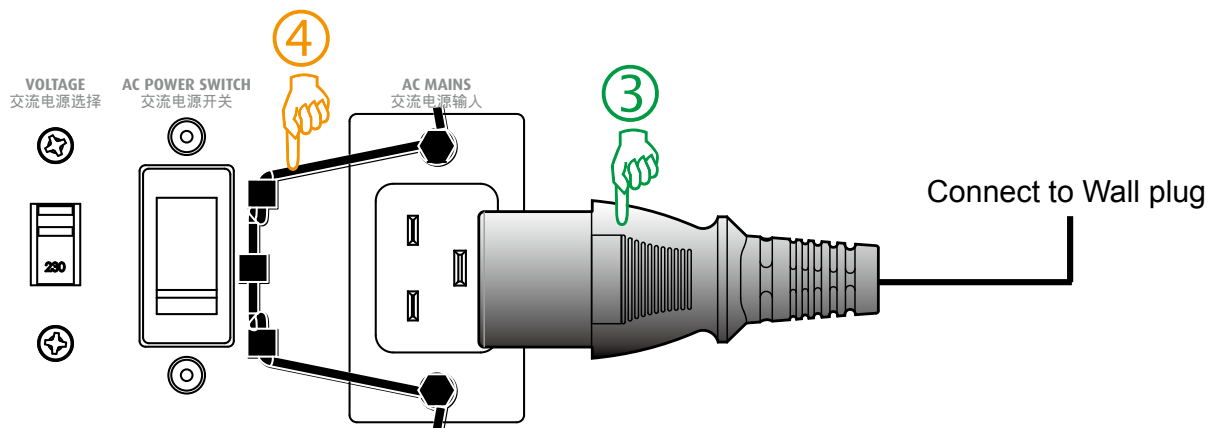
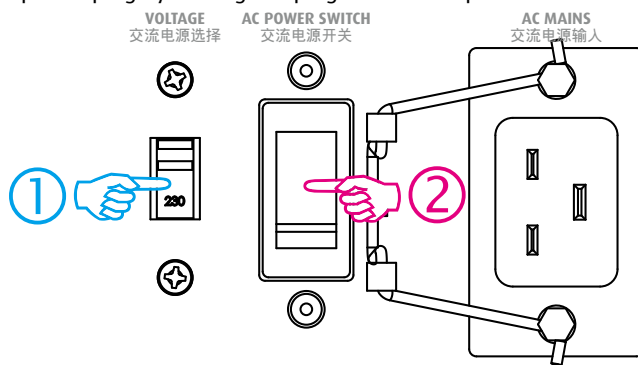

5. Connect the male side of the power cord to the local power net.

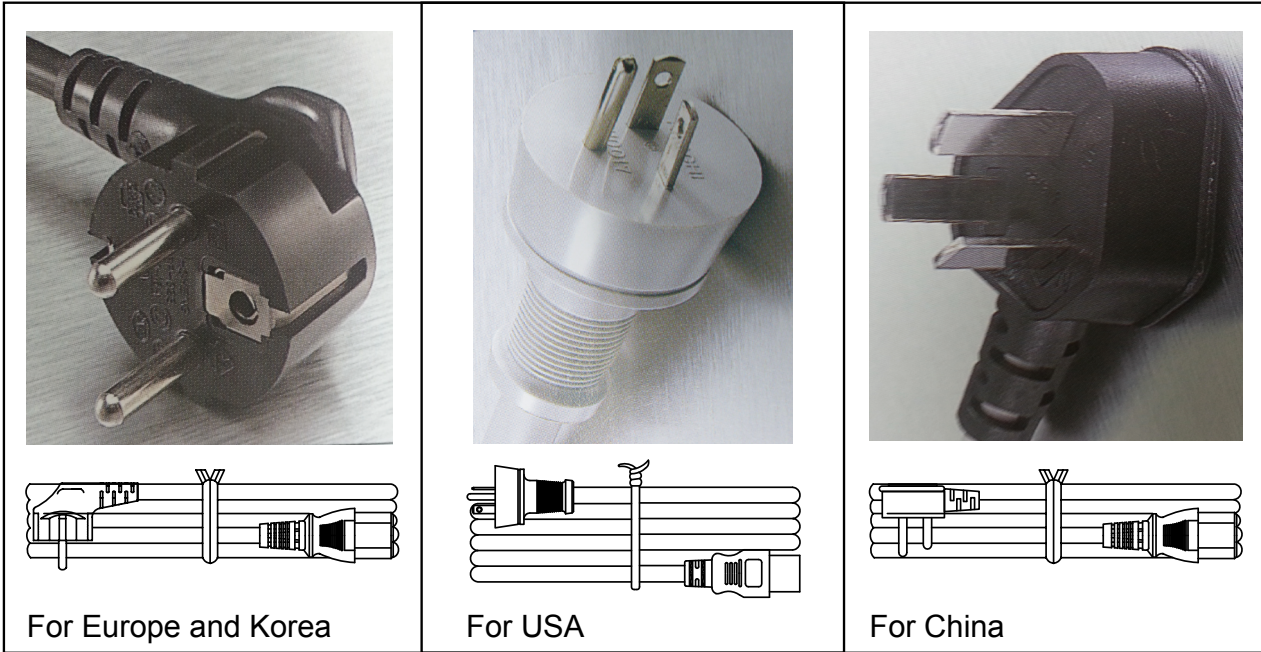

Caution: Ensure that the power net meets the power requirements of the projector.



WARNING: Do not attempt operation if the AC supply and cord are not within the specified voltage and power range.



CAUTION: Once the projector is switched to standby, the lamp cooling fans will continue to run for approximately five minutes to ensure that the projector and lamp have sufficiently cooled, at which point the fans will automatically decrease to standby. To avoid thermal stress that can lead to premature lamp failure, never unplug the power cord while the lamp cooling fans are running. Never unplug the power cord to power down the projector, first switch off the power switch and then unplug the power cord.

3.4 Alignment of a table mounted projector

How to align the projector

1. Place the projector in the desired location. Take into account the zoom range of the used lens and the size of the screen.
2. Project one of the internal hatch patterns on the screen.
3. Turn the adjustable feet in or out until the projected hatch pattern has a perfect rectangle shape and is leveled.

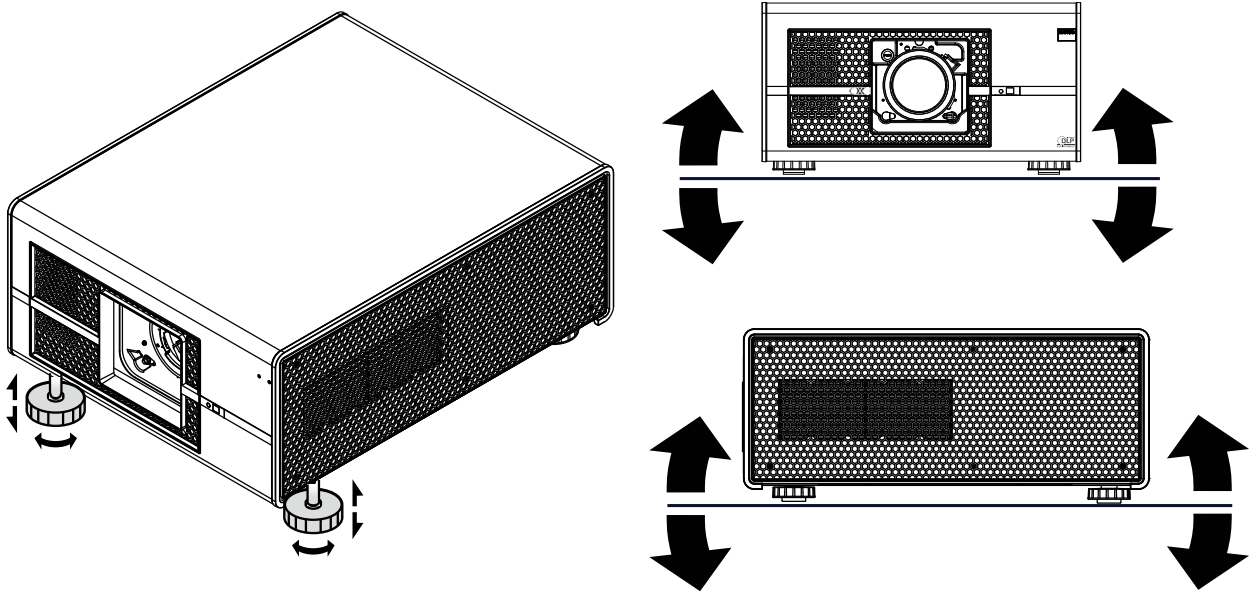

When this is achieved, the projector is set horizontal and vertical at right angles to the screen.

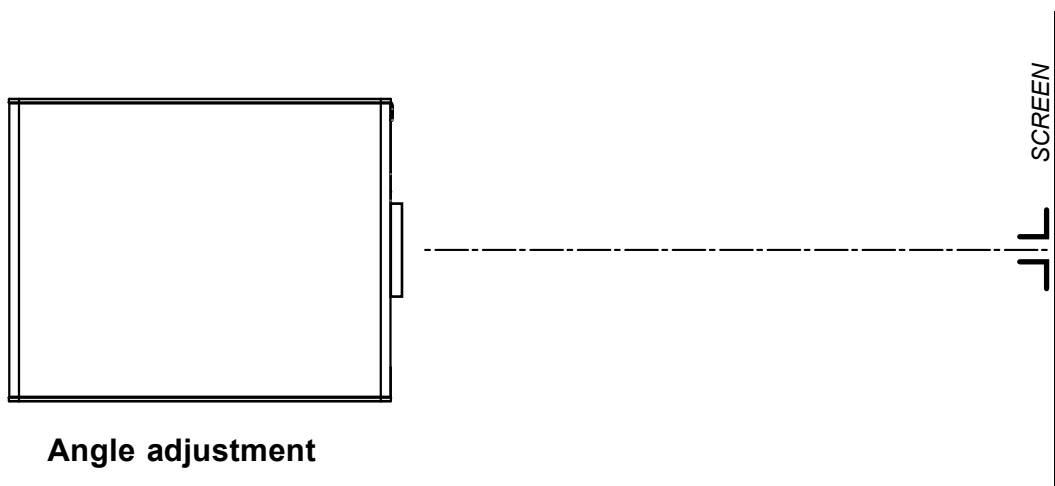
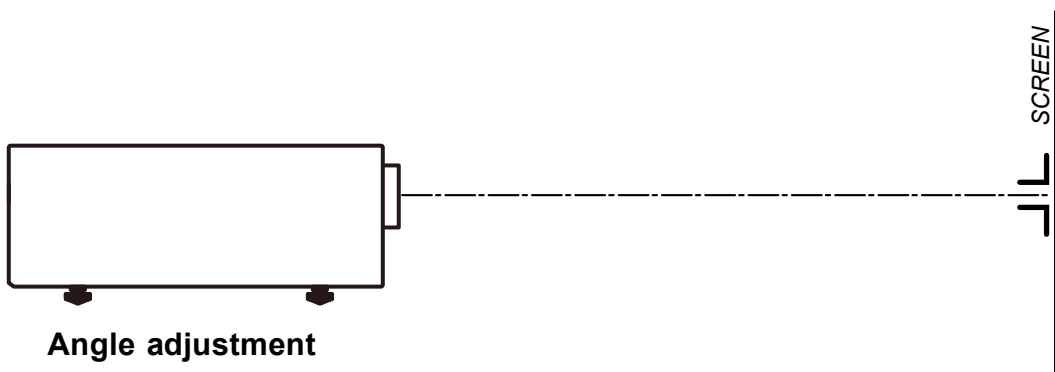

3.5 Mounting the Ceiling mount

Necessary tools

Open wrench 17 mm

How to mount

1. Turn the projector upside down.
2. Adjustment knob to the back of the projector. Make sure that the mounting holes matches the holes in the projector.
3. Insert a bolt in each corner and turn in these bolts.

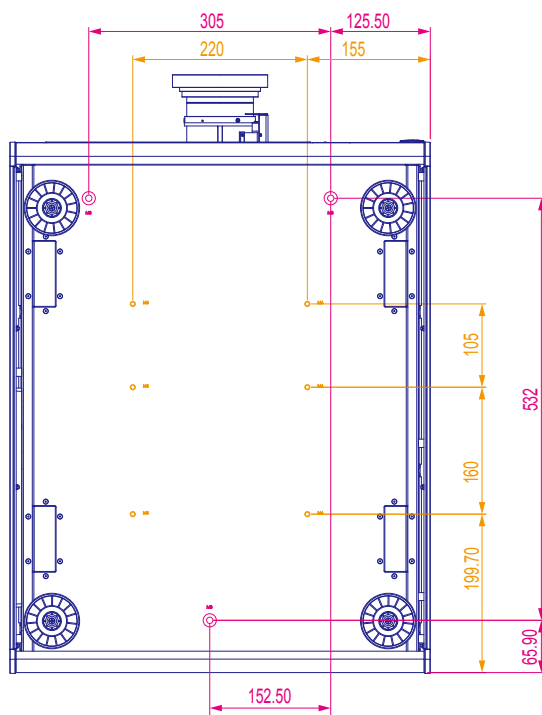
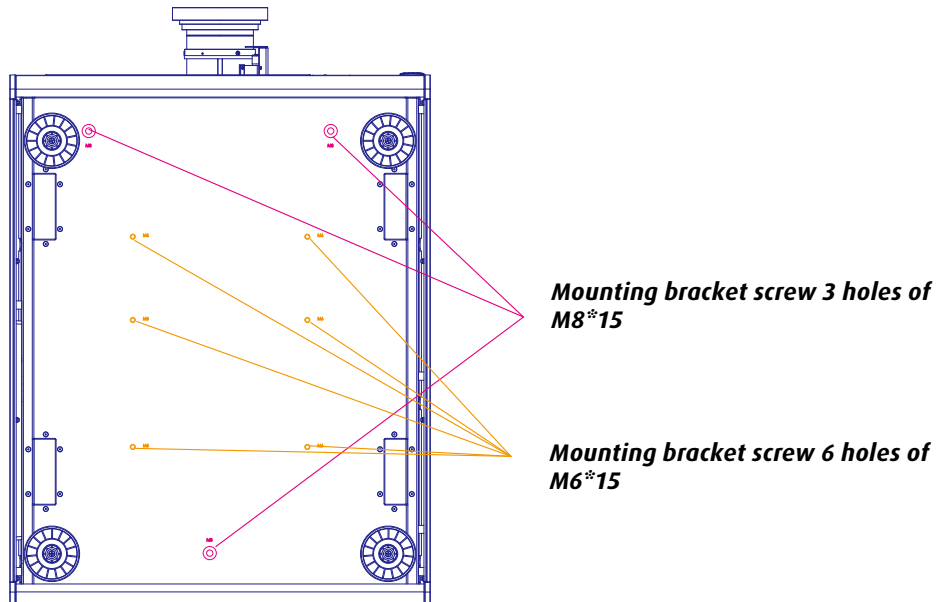

Note: Two holepatterns are available for ceiling mounting: ○ M6x15(6pcs) or □ M8x15(3pcs)

Please check your support system for compatibility.

4. PROJECTOR PARTS AND FUNCTIONS

Overview

- Projector front view
- Projector Rear view
- Input and Communication
- Status lights of LED
- Connecting the projector to other devices

4.1 Projector front view

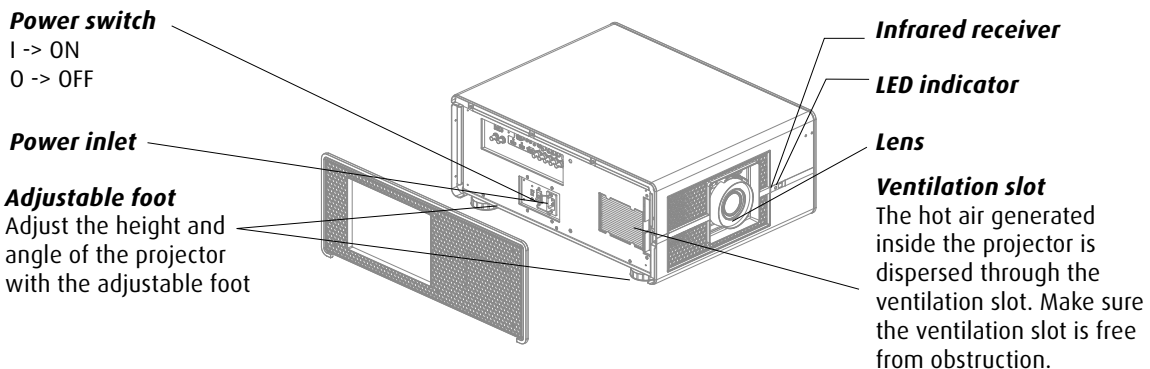

4.2 Projector Rear view

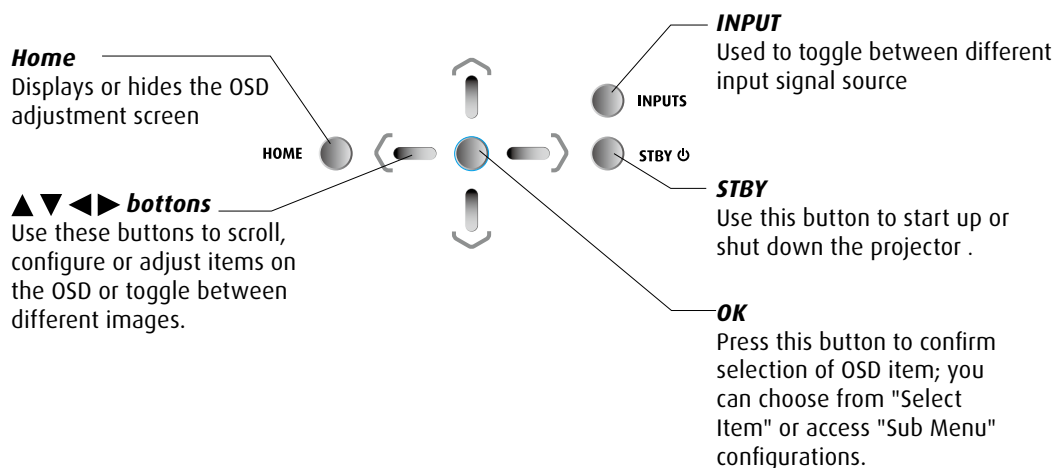
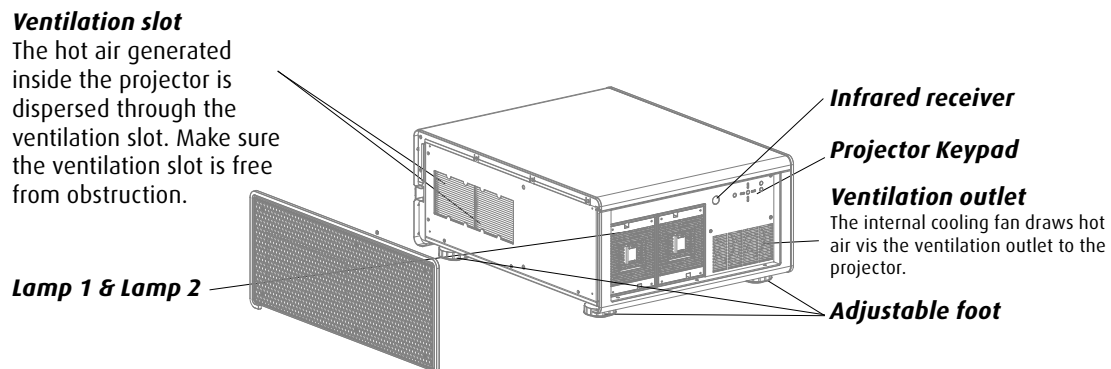

4.3 Input and Communication

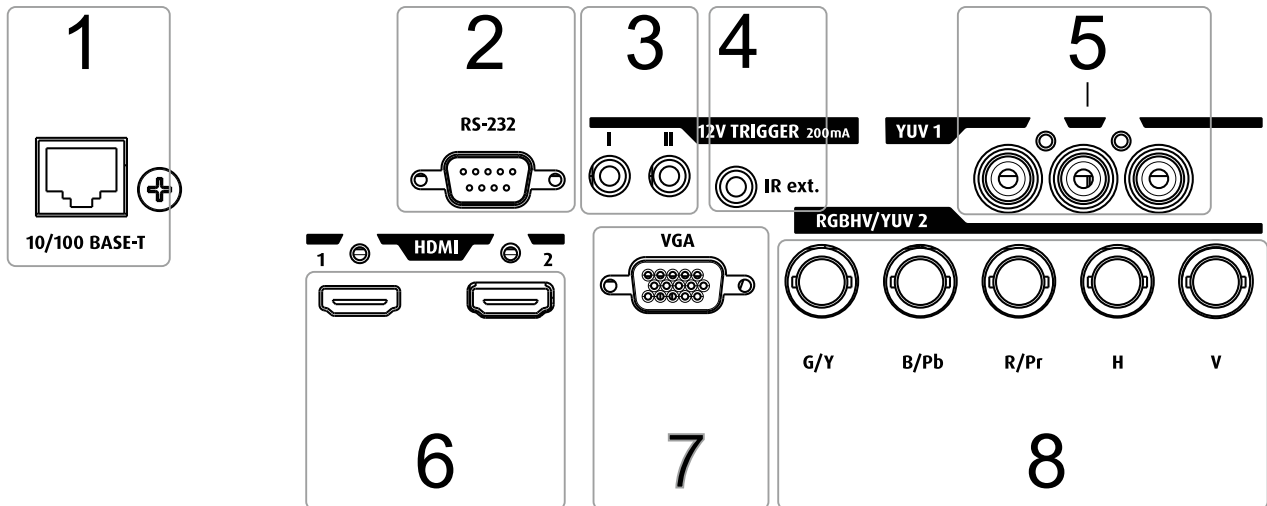

1. 10/100 BASE-T

Ethernet port

The projector can be connected to a LAN (local area network) using the Ethernet port on the communication interface. Once connected to the LAN, users are capable of accessing the projector from any location, inside or outside (if allowed) their company network using the control software: Projector Toolset. This toolset locates the projector on the network in case there is a DHCP server or the user can insert the correct IP-address of the projector to access the projector. Once accessed, it is possible to check and manipulate all the projector settings. Remote diagnostics, control and monitoring of the projector can then become a daily and very simple operation. The network connectivity permits to detect potential errors and consequently improve the time to servicing.



The connector used for the Ethernet ports (E) are of rugged Neutrik EtherCon RJ45 type, which is compatible with standard RJ45 cable connector. Straight (most common) as well as cross linked network cables can be used.

10/100 BASE-T - RJ45 port	
PIN	Description
1	TXD+
2	TXD-
3	RXD+
4	-
5	-
6	RXD-
7	-
8	-

2. RS232

RS232 input

The communication interface of the PJWU-101B projector supports RS232 serial communication.

You can use the RS232 input to connect a local PC to your PJWU-101B projector. By this way you can configure and control your PJWU-101B projector from your local PC.

Advantages of using RS232 serial communication:

- easy adjustment of the projector via PC (or MAC).
- allow storage of multiple projector configurations and set ups.
- wide range of control possibilities.
- sending data to the projector (update).
- copying data from the projector (backup).

RS232 input (Sub-D) port	
PIN	Signal
1	(No connection)
2	RD
3	TD
4	(No connection)
5	Ground
6	(No connection)
7	RTS
8	CTS
9	(No connection)

**RS232**

An Electronic Industries Association (EIA) serial digital interface standard specifying the characteristics of the communication path between two devices using either D-SUB 9 pins or D-SUB 25 pins connectors. This standard is used for relatively short-range communications and does not specify balanced control lines. RS-232 is a serial control standard with a set number of conductors, data rate, word length and type of connector to be used. The standard specifies component connection standards with regard to computer interface. It is also called RS-232-C, which is the third version of the RS-232 standard, and is functionally identical to the CCITT V.24 standard. Logical '0' is > + 3V, Logical '1' is < -

3V. The range between -3V and +3V is the transition zone.

3. 12V TRIGGER

12 V output, maximum 200mA, available when projector is not in stand by.

4. IR EXT.

Receives input signal from compatible Niles or Xantech IR repeater systems.

5. YUV1

Standard and high definition (480i/480p/576i/576p/720p/1080i/1080p) component input, connects to DVD/HD-DVD/BD player, HD set-top-box or other SD/HD input source. Also connects to RGB input from RGBS input source.

6. HDMI

HDCP compatible digital image input; connects to sources using HDMI or DVI.

7. VGA

Standard 15-pin VGA connection socket to connect to RGB, high-definition component input or PC. The projector will automatically detect the resolution of the input signal.

8. RGBHV/YUV2

Optional multi purpose input which can be inserted in the free slots.

RS232 input (Sub-D) port					
Input Signal	G/Y	B/Pb	R/Pr	H	V
RGBHV	G	B	R	H	V
Composite Video	Y	Pb	Pr	-	-

4.4 Status lights of LED

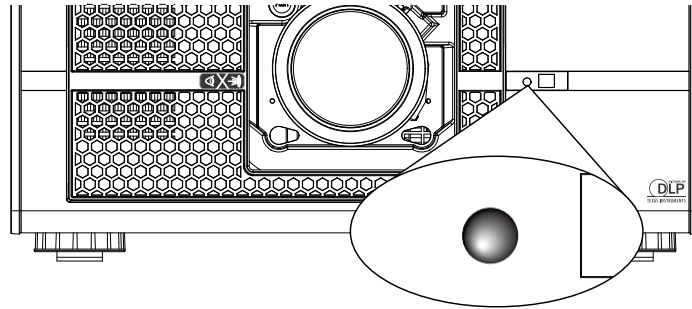

OFF/STAND BY

The LED indicator shows solid RED when the projector is off and at standby mode.

ON

The LED indicator is off when the projector is on.

ERROR

The LED indicator is blinking at a 0.25 second interval when there is error occurred in projector. Please contact authorized service personnel for help.

During start-up

The LED indicator is blinking at a 2 seconds interval when the projector power on.

	1 sec	1 sec	1 sec	1 sec	1 sec
OFF/Standby					
ON					
Error					
During Start-Up					

4.5 Connecting the projector to other devices

HDMI connection

Signals from image source offer the best projection image quality when sent through HDMI. Therefore, try to use input devices with HDMI output as the source of image.

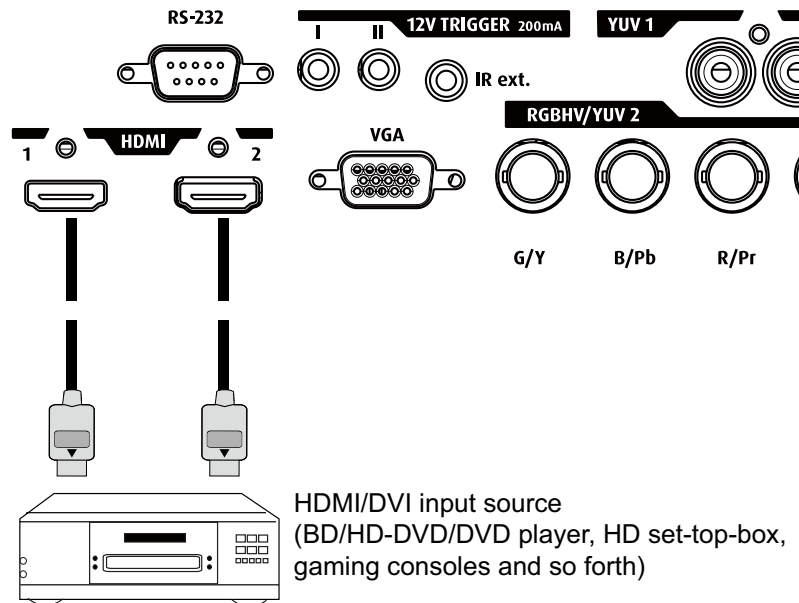

12V Trigger connection

If your home theatre system includes a projector screen, screen cover or other 12V Trigger equipment, please connect such device/equipment to the projector's 12V Trigger output as illustrated. After you have done so, your screen will lower automatically whenever you turn on your projector for your convenience.

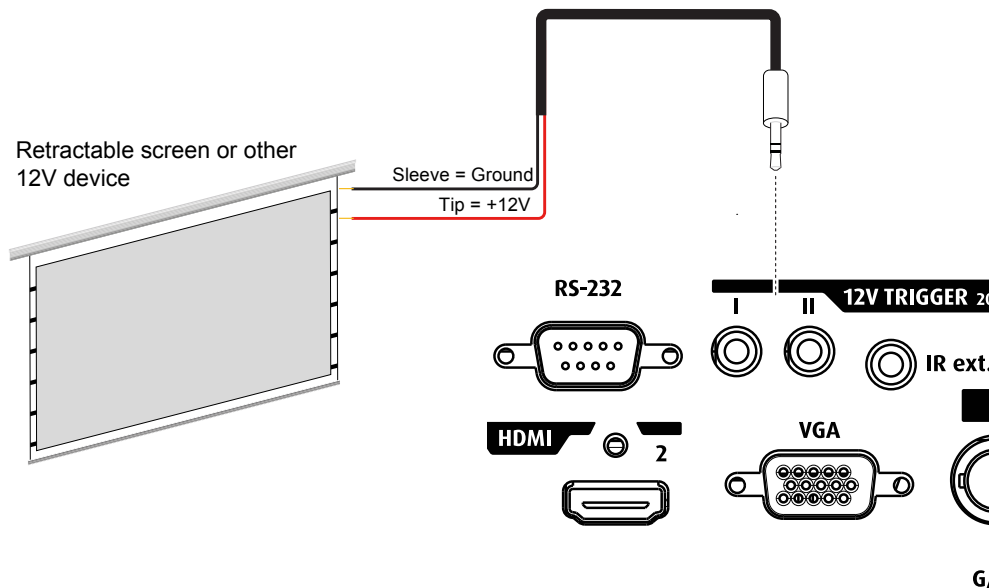

VGA connection

Connect your PC or other devices with VGA output to the VGA input connectors on the projector to be used as the source of image input.

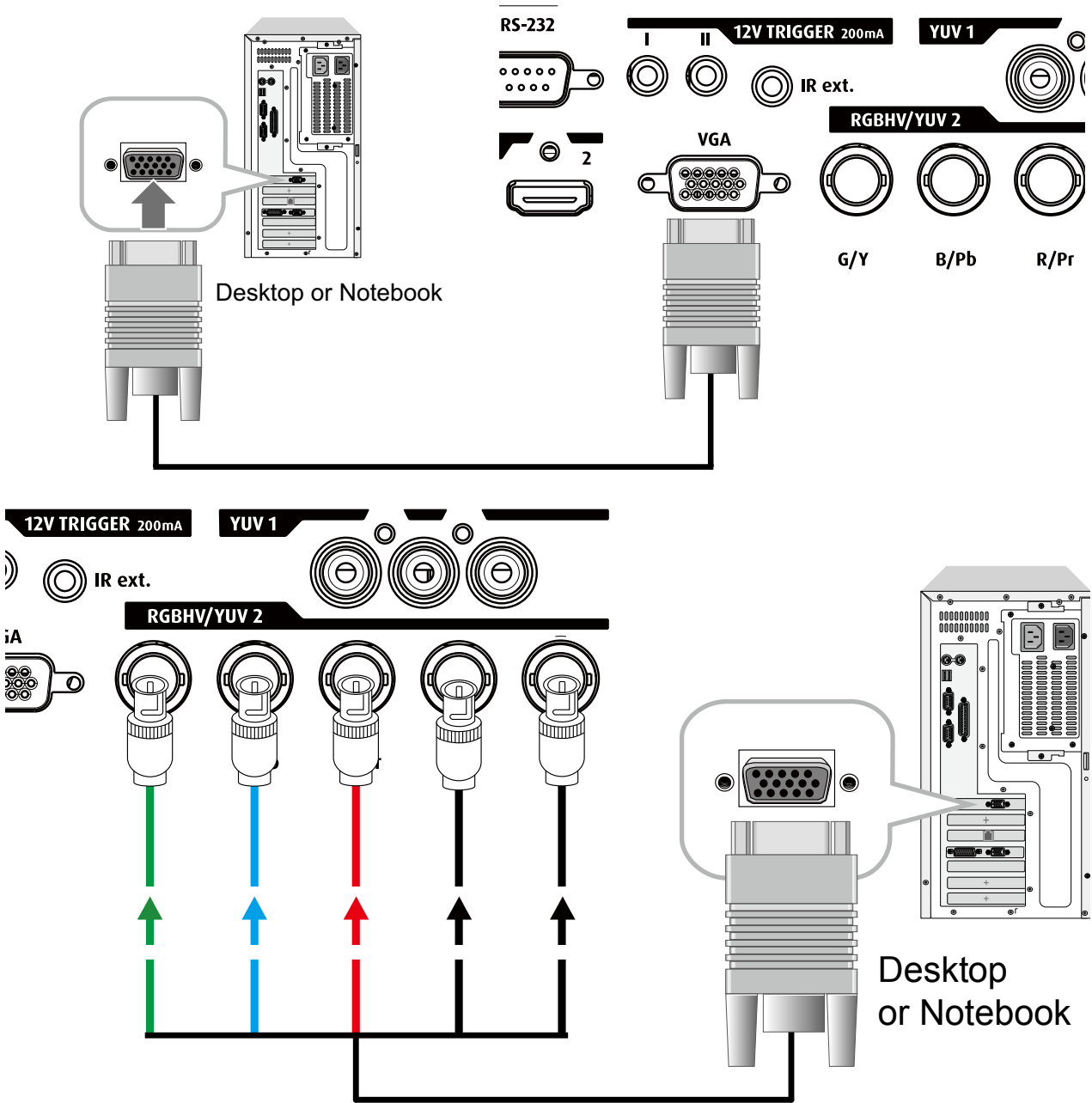

RGBs connection

If the source equipment uses composite image synchronized connectors to output VGA, please connect the green, blue and red connectors to the Y, Pb, Pr jacks at the YUV1 inputs and the synchronized output to the VIDEO jack.

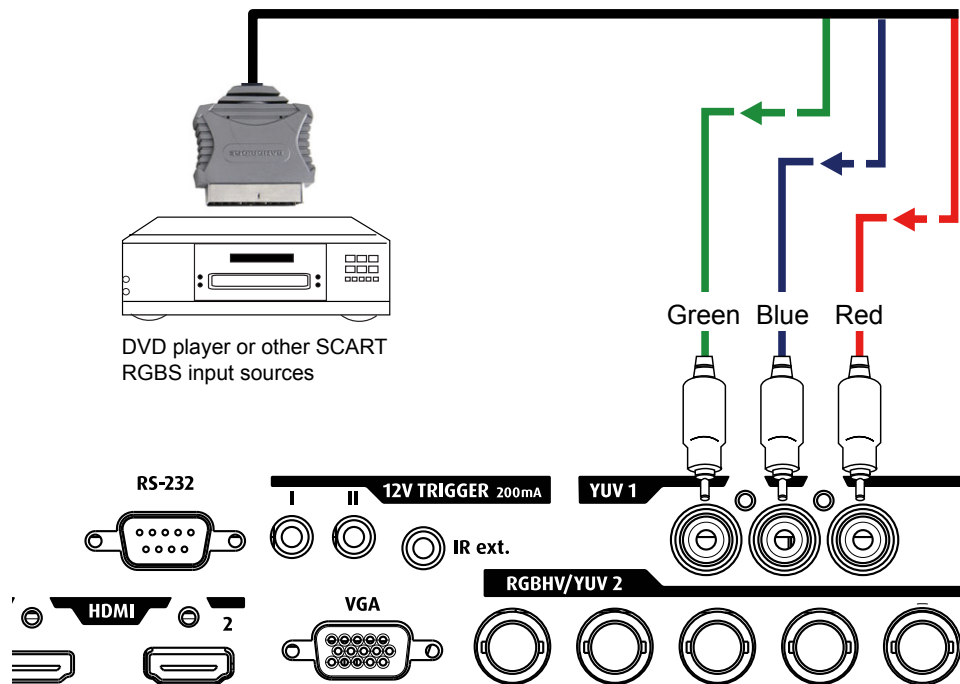

IR INPUT connection

If the projector is unable to pick up the IR signals from the remote control due to distance or obstacles (i.e. wall or cabinet doors), you can connect an external IR repeater to the projector's IR INPUT jack to extend the effective signal reception range.

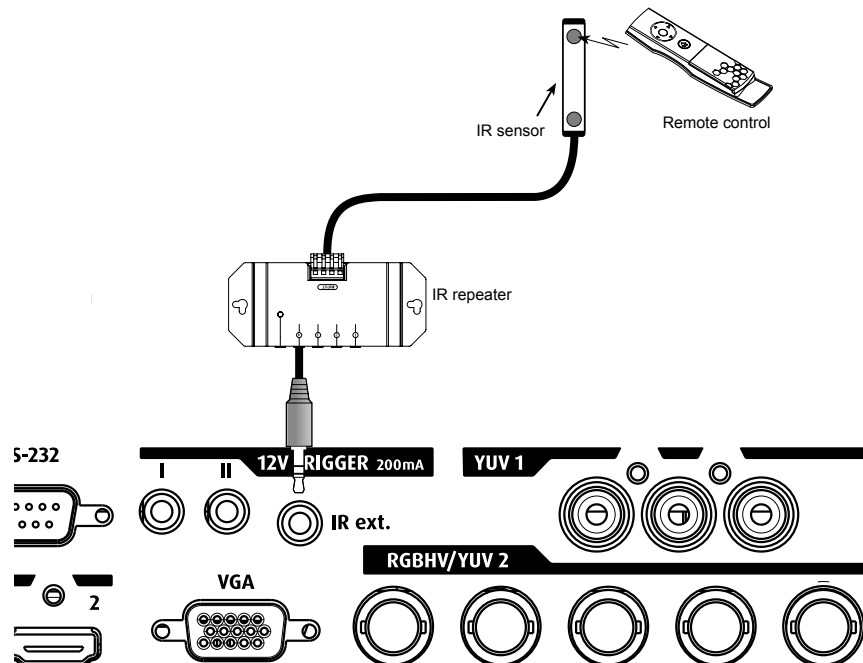

COMPONENT connection

Take the 3/5 cabled RGB component video connectors from the source equipment to the projector's YUV1 or RGBHV/YUV2 jacks.

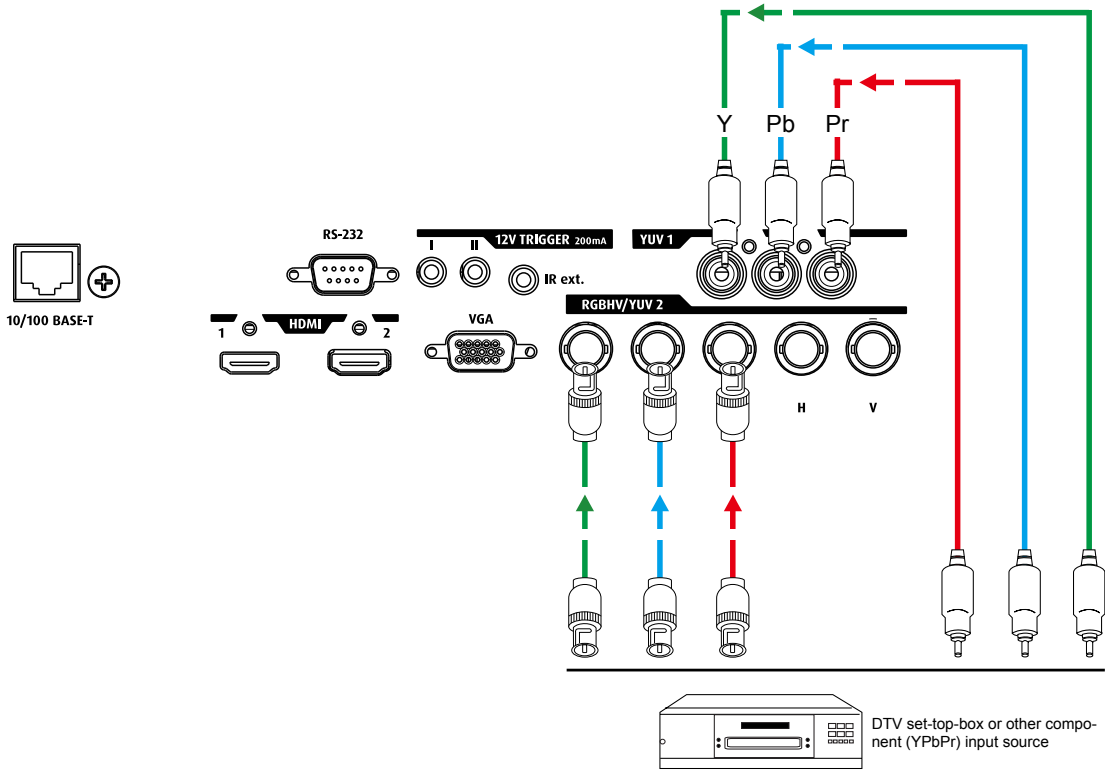

5. GETTING STARTED

Overview

- RCU & Local keypad
- Using the Remote Control and OSD Lite on Screen
- Power on projector
- Switching to standby
- Power off projector
- Range of effective remote control signal reception
- Source selection
- Changing OSD language
- Adjusting the lens by horizontal and vertical lens shift
- Introduction the OSD Lite on screen

5.1 RCU & Local keypad

How controlling the projector ?

The projector can be controlled by the local keypad or by the remote control unit.

Location of the local keypad ?

The local keypad is located on the input side of the projector.

Remote control functions.







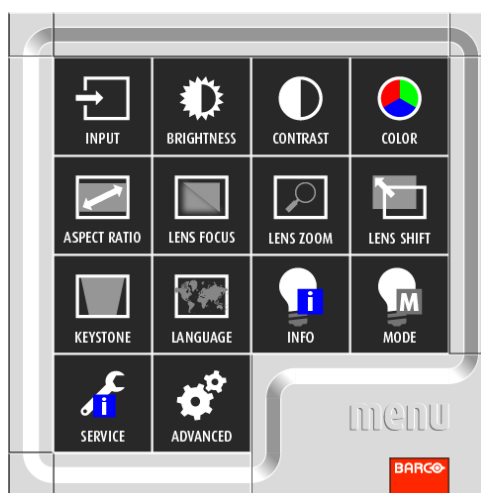



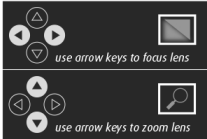

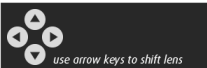

















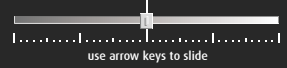





















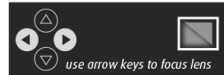





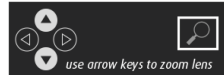





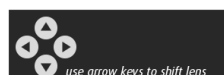























This remote control includes a battery powered infrared (IR) transmitter that allows the user to control the projector remotely. This remote control is used for source selection, control, adaptation and set up.

5.2 Remote Control and OSD Lite on Screen

Using Remote control and OSD Lite on Screen



Basic OSD Lite navigation result	RCU Lite action	OSD Lite on screen
show main menu of OSD Lite on screen	press "home"	main menu appears in bottom right corner
To move through the OSD Lite	press "arrow keys"	button will turn red when the function is available
go to desired function	press "ok"	the menu of the desired function will appear
leave the menu or clear the screen	press "home"	the main menu will be displayed or when you are in the main menu the screen will be cleared

Hotkey / Short Cut Remo result	RCU Lite -> OSD Lite action -> on screen
to quick adjust a blurry screen	 >  >  >  >  > 
mute picture and sound on the projector	 > 
unmute picture and sound on the projector	press any key
Main menu is on screen. go to button result	RCU Lite -> OSD Lite action -> on screen
select input manually	   >  go to input desired (default setting = auto select) > 
make the image brighter or darker	     default setting= middle > 
adapt the contrast between light/dark areas	     default setting= middle > 
select color preset most fitted for your image	    best condition to view "computer" images (default setting=NATIVE) > 
	  best option to view movies > 
	  100% bright > 
adjust aspect ratio	   >  go to aspect ratio desired (default setting = NATIVE) > 
adjust focus of image	     > 
adjust size of image	     > 
adjust position of image	     > 
adjust keystone	     >     > 
select language	   >  go to language desired (default setting = ENGLISH) > 
show lamp info	   > 
show lamp mode	   >  go to lamp mode desired (default setting = NORMAL) > 
show projector info	   > 
enter advanced menu	   > Use the password "◀◀▶▶▼" to enter the advanced menu > 

5.3 Power on projector

How to power on.

Press the power switch at the back of the projector to switch on this projector.

AC POWER SWITCH

- When '0' is pressed, the projector is switched off.
- When '1' is pressed, the projector is switched on.

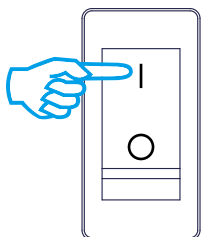

The projector starts up in standby.



When the projector is turned off, it is required to wait for at least 90 seconds to re-start the projector to complete the cooling of lamp.

Starting image projection via the standby key.

Press STBY key once on the local keypad or on the remote control.

5.4 Switching to standby

How to switch to standby

Press 2x power button to go to standby, after first push then push again to power of projector, the message is displayed.

The projector goes to standby.



All custom settings are written to the internal backup device. A message 'Saving data ...' indicates this process. Never switch off the projector while this message is displayed.



When switching to standby, an after cooling process will start to cool down the projector. The after cool time depends on the temperature inside the projector and can vary from 30 second to 5 minutes.

5.5 Power off projector

How to power off

1. Press first Standby.
2. Let cool down the projector until the fan speed decreases. At least 5 minutes.
3. Switch off the projector with the power switch. '0' must be pressed.



CAUTION: Never switch off the projector while the message 'Saving data ...' is displayed !

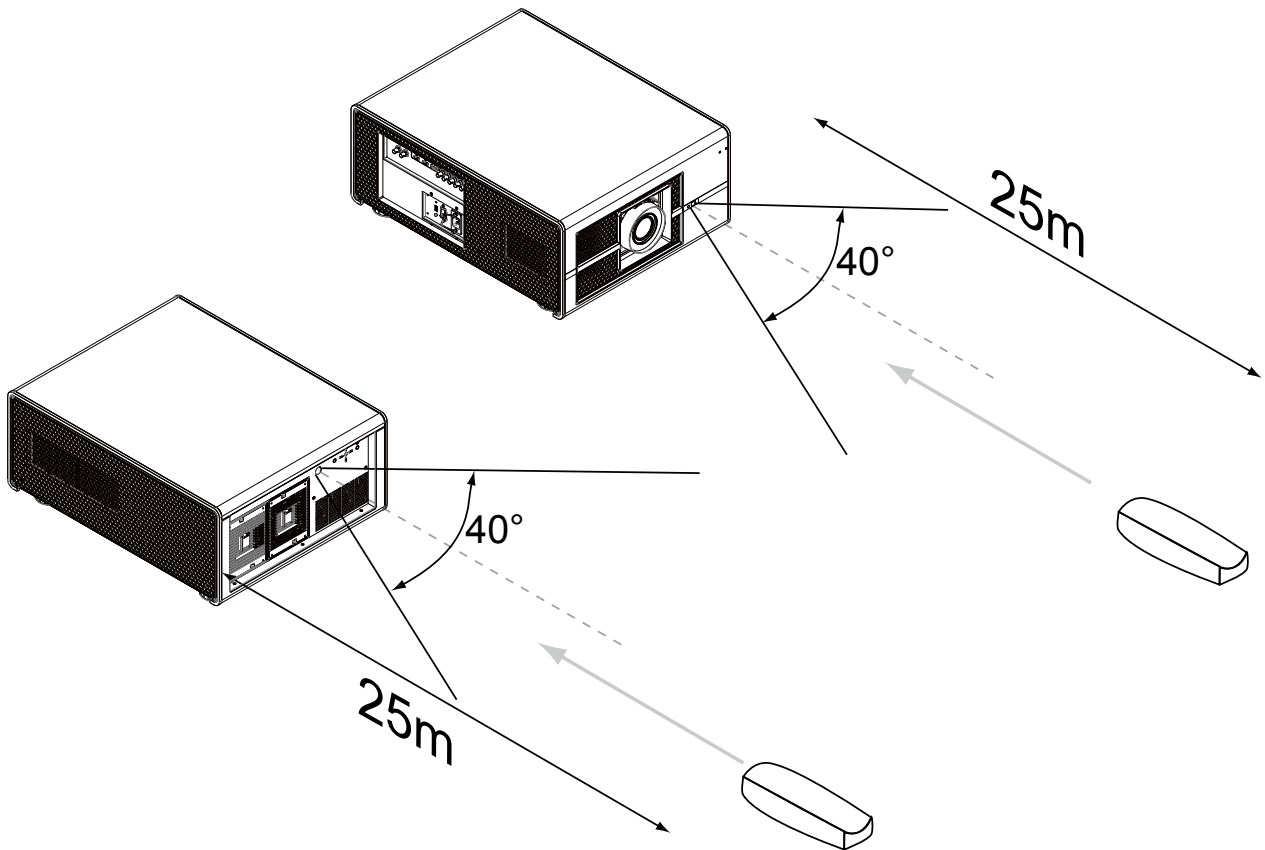

5.6 Range of effective remote control signal reception

The diagram below illustrates the range of effective remote control signal reception.



Avoid placing the remote control at places of high temperature or humidity as it could cause the remote control to malfunction.

5.7 Source selection

Press  on the remote control to activate OSD Lite on Screen, then select "" for the desired source. Or press  on the keypad to select the input source.

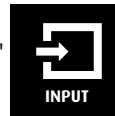

5.8 Changing OSD language

By factory default, the OSD menu of the projector is displayed in English. If you wish to switch to a different language, Press  on the remote control , select the language you prefer for the OSD.

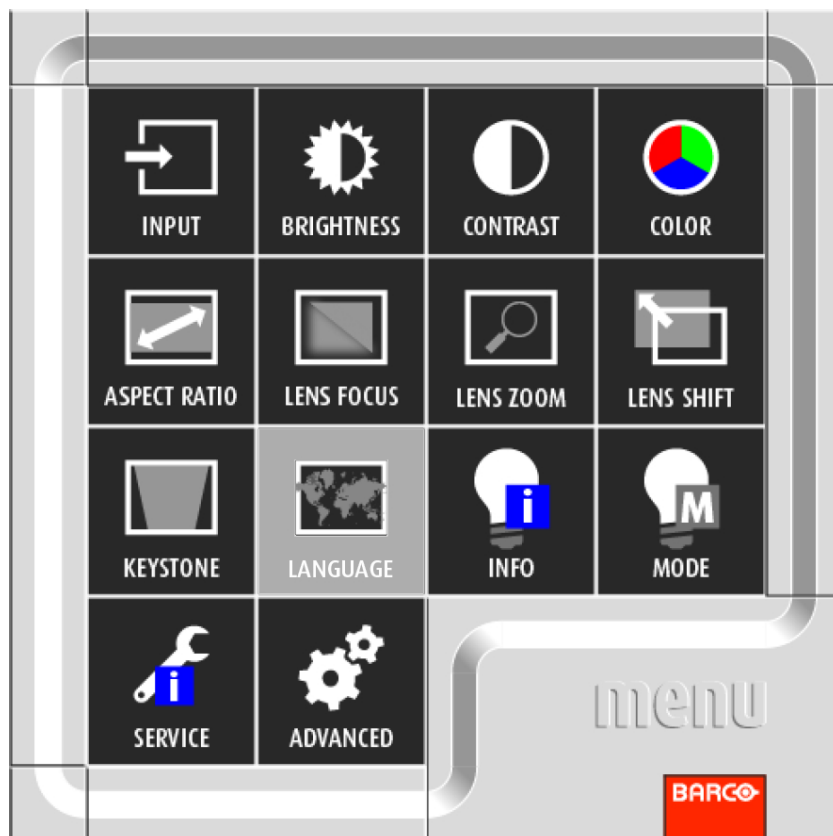

5.9 Adjusting the lens by horizontal and vertical lens shift

Via the remote control directly

Press the  button on the remote control, then select "", use the     buttons to adjust the horizontal or vertical position of the lens.

5.10 Introduction the OSD Lite on screen



Press  on RCU or press "Home" on projector rear cover, You can see the OSD Lite on screen as above picture.

INPUT

Use this function to select the input source. You can choose HDMI1, HDMI2, VGA, YUV1 and RGBHV/YUV2. Refer to [page 37: 7. INPUT](#) for further message.

BRIGHTNESS

Adjust the level of black in the image to increase or decrease image brightness. Refer to [page 41: 8.3 Brightness](#)

CONTRAST

Adjust the level of white in the image to increase or decrease image contrast. Refer to [page 41: 8.2 Contrast](#).

COLOR

Adjust the image's color saturation. When oversaturated, the colors in the image will appear to be very bright and vivid; on the other hand, if colors are undersaturated, the image will appear to be washed out.

ASPECT RATIO

You can select different aspect via this function. Refer to [page 45: 8.8 Aspect Ratio](#).

LENS FOCUS

Use this function to adjust the image from fuzzy to clear.

LENS ZOOM

Use this function to zoom in or zoom out the image's size.

KEystone

Use this function to adjust the frame from the tilt to not inclined. Refer to [page 56: 11.6 Keystone](#)

LANGUAGE

Use this function to select the different language of the OSD Lite on screen. Refer to [page 61: 12.9 Language](#).

INFO

Show the information of lamp.

MODE

Select ECO, Normal and Power mode of lamp. Refer to [page 52: 10.2 Mode](#).

SERVICE

Display this projector's information. Refer to [page 63: 13.2 Service message of the projector](#)

Advanced

This function is for further adjust the projector. For professional use. Refer to [page 35: 6. ADVANCED OSD MENU](#)

6. ADVANCED OSD MENU



The advanced menu only available for Professional use. Need enter the password to use this function.

Overview

The Advanced menu is the further function to control and align the projector, the following functions can be done:

- Advanced OSD introduction.
- Input setup: different Input settings can be adjusted such as specific input slot settings, locking, native resolution and no signal settings.
- Image adjustment: these adjustments are organized per image source and contain the aspect ratio, timings and image settings.
- Layout adjustment: set up of the main window and the picture in picture window.
- Lamp: manage the lamp mode, the lamp use, lamp type and history
- Alignment: groups all controls necessary during the setup of the projector onto a screen.
- Control: contains the accessibility settings of the projector, such as address and communication setup.
- Service: contains information about how the projector is performing. This information will be useful when calling for a service intervention.

6.1 How to activate the Advanced OSD menu

Press the  button on the remote control or Home on the Projector Keypad to call the Basic OSD Lite on screen.



Select the "ADVANCED" and press the password then the screen will show the advance OSD as below:



The password for the advanced OSD is ◀◀▶▶▼

BARCO PJWU-101B						
INPUT	IMAGE	LAYOUT	LAMPS	ALIGNMENT	CONTROL	SERVICE
Input Selection		Enter				
Input Configuration	<	RGB-Video	>			
Input Locking	<	60Hz	>			
Auto Power Off	<	Off	>			
Auto Power On	<	On	>			
No Signal	<	Logo	>			
Auto Image Adjust	<	Always	>			

6.2 How to navigate in the Advanced menu structure?

Once in the Advanced menu structure, use the ▲ or ▼ key on the remote control or on the local keypad to scroll through the items in the displayed menu. The selected item will get a background color. To activate a selected submenu or function, press



on the remote or OK on the projector.

When on a submenu, to return one step to the parent menu, press ◀. To escape the menu structure when on a menu, press HOME.

How to make an OSD adjustment?

With the remote control or the local keypad navigate through the Advanced menu structure until the desired item is selected.

Press the ▲ or ▼ key until the desired item is reached. Press or OK to finalize the adjustment.

With the local keypad or remote control, press the ▲ or ▼ key until the desired value (setup) is reached. Press HOME to finalize the adjustment.

Direct adjustment within the menu:

BARCO PJWU-101B						
INPUT	IMAGE	LAYOUT	LAMPS	ALIGNMENT	CONTROL	SERVICE
	Contrast		< 100 >			
	Brightness		< 100 >			
	Sharpness		< 100 >			
	Noise Reduction		< 100 >			
	Color Temperature		< Native >			
	Input Balance		Enter			
	Aspect Ratio		< Unscaled >			
	Timings		Enter			
	Auto Image		Execute			

Use the ◀ or ▶ key to directly adjust the current value.

or, Via bar scale adjustment :

Once an item is selected, press or OK to open the bar scale menu.



Use the ◀ or ▶ key to adjust the current value. The bar scale will move accordingly.

Press or OK to finalize the adjustment. or,

When the bar scale is displayed, via direct input. Press or OK to activate the input field.

6.3 Advanced menu memory

Each menu with sub menus, remembers its last selected sub item even when leaving the menu structure and that as long as the projector is running. When restarting the projector from stand-by, the menu memory is reset.

After re-opening the main menu and selecting an item, the previous selected sub item of that selected item is highlighted and can be opened just by pressing or OK.

7. INPUT

Overview

- Input menu overview
- Input Selection
- Input Locking
- Auto Power Off
- Auto Power On
- No Signal
- Auto Image Adjust

7.1 Input menu overview

INPUT	Input Selection	HDMI1 HDMI2 VGA YUV1 RGBHV/YUV2
	Input Configuration	Auto YUV HD YUV STD RGB-PC RGB-Video
	Input Locking	Auto 48Hz 50Hz 60Hz
	Auto Power Off	On Off
	Auto Power ON	On Off
	No Signal	Logo Blue Black White
	Auto Image Adjust	Off Auto Always



Each input module must be configured before these module can be used. This configuration is necessary so that the projector knows which type of signal is connected to its input.

BARCO PJWU-101B						
INPUT	IMAGE	LAYOUT	LAMPS	ALIGNMENT	CONTROL	SERVICE
Input Selection		Enter				
Input Configuration		< RGB-Video >				
Input Locking		< 60Hz >				
Auto Power Off		< Off >				
Auto Power On		< On >				
No Signal		< Logo >				
Auto Image Adjust		< Always >				

7.2 Input Selection

Use this function to specify the source of image connected to the rear of the projector. For instance, if you have connected your PC as the video input source, you can choose RGB D-15(RGB-HV/SOG) to be the input for image projection. Options of input available on the projector include: **HDMI1**, **HDMI2**, **RGB D-15(RGB-HV/SOG)**, **YUV1(RGB-S)**, **YUV2(RGBHV/YUV2)**.

7.3 Input Configuration

Select Input Configuration from the Advanced menu to choose the color space of the source signal for HDMI, VGA, and component connections.

The default setting, Auto, functions as follows:

AUTO

The Auto setting determines the correct color space to use. If it does not, you can force the PJWU-101B to use a specific color space. Choose one of the following:

- Auto(default)
- YUV-HD
- YUV-SD
- RGB-PC
- RGB-Video

HDMI

For component SDTV and EDTV resolutions, YUV STD is used. For other component video resolutions, YUV HD is used.

VGA

YUV STD is used for SDTV and EDTV sources, and YUV HD for all other sources.

Component

For SDTV and EDTV resolutions, uses the YUV STD. For all other resolutions YUV HD is used.

7.4 Input Locking

What is possible?

The output signal can be locked on an internal sync signal or on the sync signal of one of the input sources. Or it can follow the input of the Main window or Pip window. When locked to the corresponding input sync, the output will be shown without movement artifacts. With locking to a specific input, a set of projectors can be kept in sync, no matter what input image is shown.

Use this function to specify the frequency of the image input signal. You can let the projector determine the optimal projection frequency or force the projector to project image at the frequency you specify.

Auto

The preset value for this function is **Auto**. If you specify vertical refresh frequency from the input device to be between 48~62Hz, the projector will automatically lock the frequency of the input signal so that both signal input and output will be refreshed at the same frequency in order to achieve optimal image output. If the frequency of the input signal falls between 24~31Hz, the projector will automatically double the vertical refresh frequency. If the frequency of the input signal falls between 31~48Hz or exceeds 62Hz, the projector will automatically set the frequency to 60Hz.

48Hz, 50Hz, 60Hz

Choose this option to set image output frequency at 48Hz, 50Hz or 60Hz



If you enable PIP, the projector will automatically synchronize the frequency of the PIP input signal with the main input signal.

7.5 Auto Power Off

The default value is OFF. If you set it to ON, the projector will automatically shut down after 20 minutes without input signal.

7.6 Auto Power ON

The default value is Off. If you set it to ON, the projector will automatically start up when it is connected to AC power. If you plug the projector's power cord into an AC socket with a switch, you can use this function to start up the projector using the socket's switch instead of the remote. If you do not need this function, please set it to Off.

7.7 No Signal

When no signal is available at the selected input, the output can be set to blue or black or a personal defined logo can be displayed or the projector can shutdown after a certain time or auto dimming can be started.

There have Logo, Blue, Black and White can choose.

7.8 Auto Image Adjust

You can configure the Auto Image Adjust function to one of the following three modes:

Off =NEVER

Auto =When not done before(or when done first time)

Always =When new source selected or new source connected.

8. IMAGE

Overview

- Image menu overview
- Contrast
- Brightness
- Sharpness
- Noise Reduction
- Color Temperature
- Input Balance
- Aspect Ratio
- Timings
- Auto Image

8.1 Image menu overview

IMAGE	Contrast	0~200
	Brightness	0~200
	Sharpness	0~200
	Noise Reduction	0~200
	Color Temperature	3200K 5400K 6500K 9300K Native
	Input Balance	Black Balance Offset Red Offset Green Offset Blue Offset White Balance Red Gain Green Gain Blue Gain
	Aspect Ratio	5:4 4:3 16:10 16:9 1.88 2.35 Letterbox Native Unscaled
	Timings	H Total H Start H Phase V Start
	Auto Image	Execute



Depending on the type of the connected source, some settings are grayed out

BARCO PJWU-101B						
INPUT	IMAGE	LAYOUT	LAMPS	ALIGNMENT	CONTROL	SERVICE
	Contrast		< 100 >			
	Brightness		< 100 >			
	Sharpness		< 100 >			
	Noise Reduction		< 100 >			
	Color Temperature		< Native >			
	Input Balance		Enter			
	Aspect Ratio		< Unscaled >			
	Timings		Enter			
	Auto Image		Execute			

8.2 Contrast

The contrast function is used to adjust the contrast between the light and the dark areas of the displayed image. It applies a gain to the red, green and blue signals.

Contrast adjustment can be done with the Contrast key on the RCU or via the menu structure.

The following image illustrates the results of direct contrast adjustment using a random image:

◀ Lowered contrast



Original image



Enhanced contrast ▶



8.3 Brightness

The brightness function is used to adjust the black level in the input picture. It adds or subtracts an offset, or bias in to the red, green and blue signals.

Brightness adjustment can be done with the Brightness key on the RCU or via the menu structure.

It is recommended that you adjust the image to the following status:

- The darkest black bar of the image should disappear into the background.
- The dark gray area should be barely visible.
- The light gray area should be clearly visible.
- The white area should appear real and mellow.
- The image should only display black, gray and white (with no other colors).



Contrast and Brightness are interrelated options that affect one another; when you adjust one of them, you might have to fine tune other settings to get the best projection results.

The following image illustrates the results of direct brightness adjustment using a random image:

◀ Reduced brightness



Original image



Enhanced brightness ▶



8.4 Sharpness

The adjustment of sharpness primarily changes the value of high frequency detail. You can connect the projector to an external image source to display an image resembling the one shown below to adjust the image sharpness.

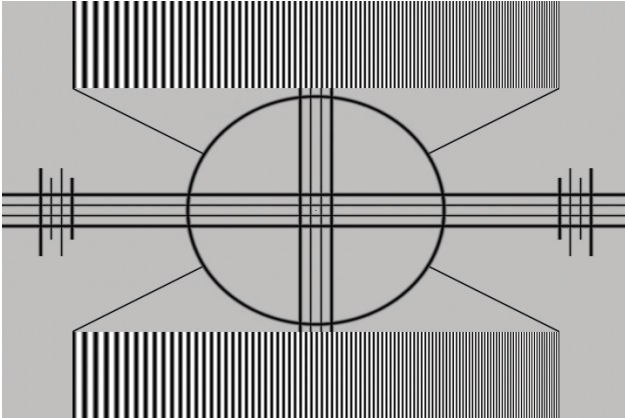

The following image illustrates the results of direct sharpness adjustment using a random image:

◀ Reduced sharpness

Original image

Enhanced sharpness ▶



8.5 Noise Reduction

Use ◀▶ to adjust the noise of the projected image. This function is suitable for the elimination of image noise from interleaving SD input. Generally speaking, reducing image noise will lower the value of high frequency detail and make the image appear more mellow.



noise reduction



8.6 Color Temperature

You can choose from **3200K**, **5400K**, **6500K**, **9300K** and **Native**.

Color temperature refers to the change in light color under different energies that is perceived by the naked eye. The change of color temperature from low to high for visible light goes from orange red → white → blue



The projector's default color temperature is set at Native. As color temperature rises, the image will appear to be more blue; as it decreases, the image will appear redder. When you choose "Native", the projector will disable the white adjustment function of the input device.

8.7 Input Balance

Unbalanced color signals

When transporting signals, there is always a risk of deterioration of the information contained in the signals.

In case of information contained in the amplitude of the signals which is the case of data color signals (R, G, B), image 9-29, we are quite sure that the amplitude of these color signals is subject to alterations.

An example of alteration may be a DC component added to the signal, in the form of a DC offset repositioning the black level, since this black level ("brightness") will become crucial later on (clamping circuit) it will result in "black not being black".

Another value that is subject to alteration is the amplitude of the signal, resulting in an altered "Gain" of the signal ("white level" or contrast).

The alterations of the three color signals will happen independently i.e. the colors will end to be unbalanced, image 9-30

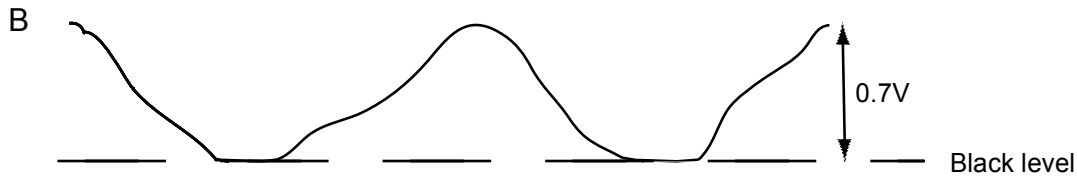
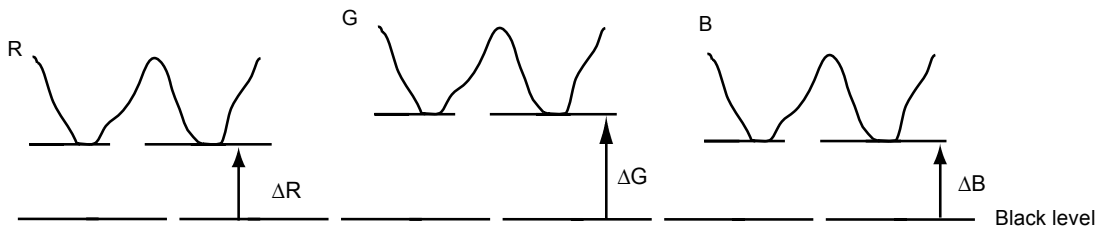

Image 9-29



One can conclude here that a good color tracking can only be met by using three previously (input) balanced color signals

Analog Digital Conversion

The analog color signals must pass through an Analog/Digital conversion circuit prior to any digital processing in the PMP. A typical ADC transforms the analog value into an 8 bit coded digital signal.

The graphic shows that when converting a signal containing a DC offset component the range of the converter is not optimally used.

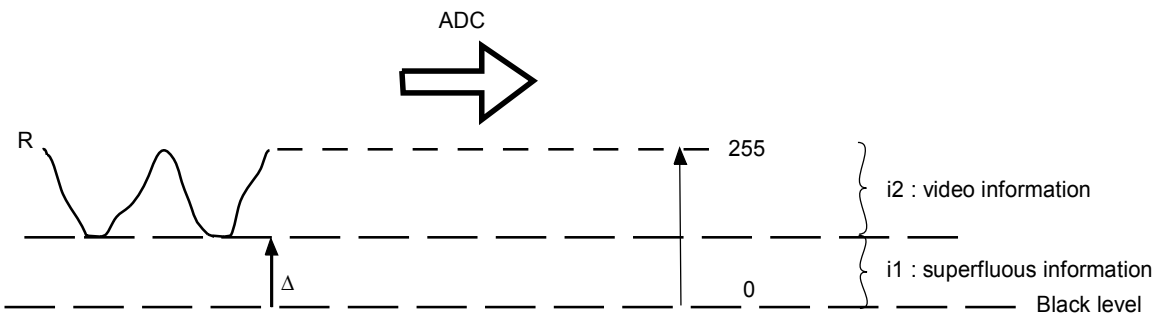

One can conclude here that a good data conversion can only be met by using three previously (input) balanced color signals

The objective of input balancing

The objective in input balancing is to "set" the same black level and the same white level for the three colors of a particular input source.



Black level setting : brightness

White level setting : contrast

The same absolute black and white level for the three colors allows the same reference for Brightness and Contrast control of the picture !

These two references also set the range in which the ADC will work for that particular source (this explains also why each input balance setting is linked to a particular source and thus saved in the image file).

Adjusting the input balance

To balance the three color signals of a particular source there are conditions; in fact we must know the black and the white level of the source i.e. :

1. The source in question must be able to generate a white signal, ideally a 100% white (background) full screen pattern
2. The source in question must be able to generate a black signal, ideally a 100% black (background) full screen pattern



White balance : In the projector, we will set the contrast for each color until we get a 100% light output picture when projecting a 100% white image (image A)

Black balance : In the projector, we will set the brightness for each color until we get a 0% light output picture when projecting a 100% black image (image B).



The changeover from min to max is indicated by the apparition of bright spots also called "digital noise"

An alternative to a full screen White/black pattern is the standard gray scale pattern, the white bar will be used for white balance and the black bar for black balance.



Offset

This refers to the control of color imbalance in the darker areas of the projected image. It is recommended that you use an external test image with many areas of dark and gray colors (i.e. an image of 30IRE-window). If you notice minimal amount of red, green or blue in the gray areas, adjust the offset of the corresponding color accordingly. This function will shift the entire color spectrum for the whole image and change its brightness.

Gain

This refers to the control of color imbalance in the brighter areas of the projected image. It is recommended that you use an external test image with many areas of white (i.e. an image of 80IRE-window). If you notice minimal amount of red, green or blue in the gray areas, lower the gain of the corresponding color accordingly. This function is used to increase or decrease the range of color input for the entire image.

Generally speaking, as gain increases, the contrast of the image will become lower. By increasing the offset, the image brightness will become lower.

Black Balance Offset

This function involves the adjustment of the following red, green and blue offsets. The text itself is decorative.

- Red Offset
Press ◀▶ to adjust the offset of red in dark scales.
- Green Offset
Press ◀▶ to adjust the offset of green in dark scales.
- Blue Offset
Press ◀▶ to adjust the offset of blue in dark scales.

White Balance

This function involves the adjustment of the following red, green and blue gains. The text itself is decorative.

- Red Gain
Press ◀▶ to adjust the gain of red in bright scales.
- Green Gain
Press ◀▶ to adjust the gain of green in bright scales.
- Blue Gain
Press ◀▶ to adjust the gain of blue in bright scales.

8.8 Aspect Ratio



Relation between the horizontal & vertical dimension in which the window will be displayed, e.g. 4 by 3 or 16 by 9. Can also be expressed as a decimal number, such as 1.77. The larger the ratio or decimal, the wider the image (or the less the image is squared).

The aspect ratio setting forces the projector to project an image using a defined aspect ratio.

Aspect ratio	Description
5:4	Workstation format
4:3	Standard television format
16:10	Wide screen cinema format (WUXGA format)
16:9	Wide screen television format / anamorphic format
1.88	Digital cinema 2K aspect ratio
2.35	Film format
Letterbox	1.33:1
Native	Scale image to fit screen
Unscaled	Unscaled format

The projector's full image size is 16:10 (1920×1200 dots).The following diagram illustrates the difference in various aspect ratio settings:

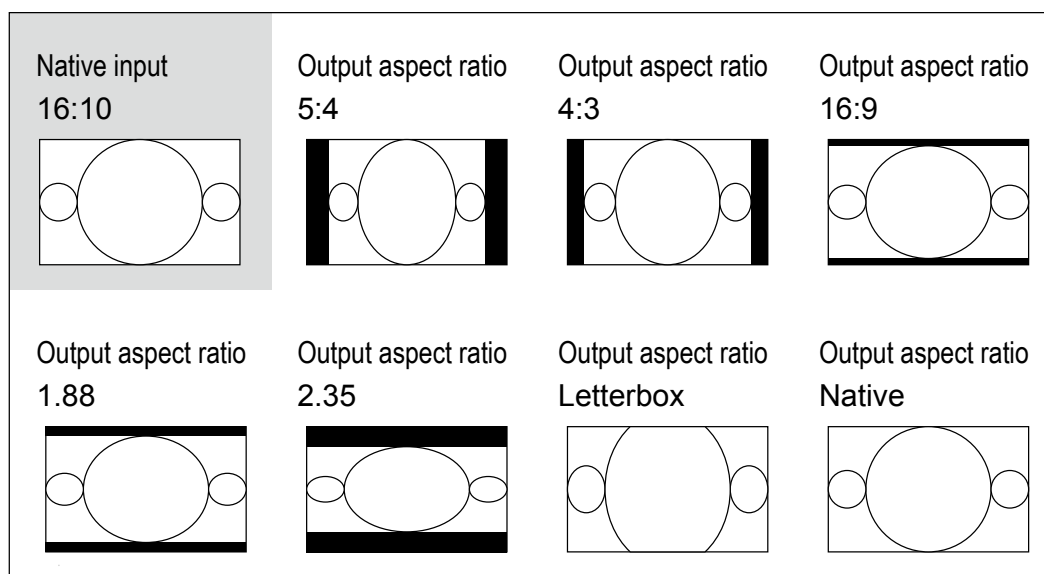

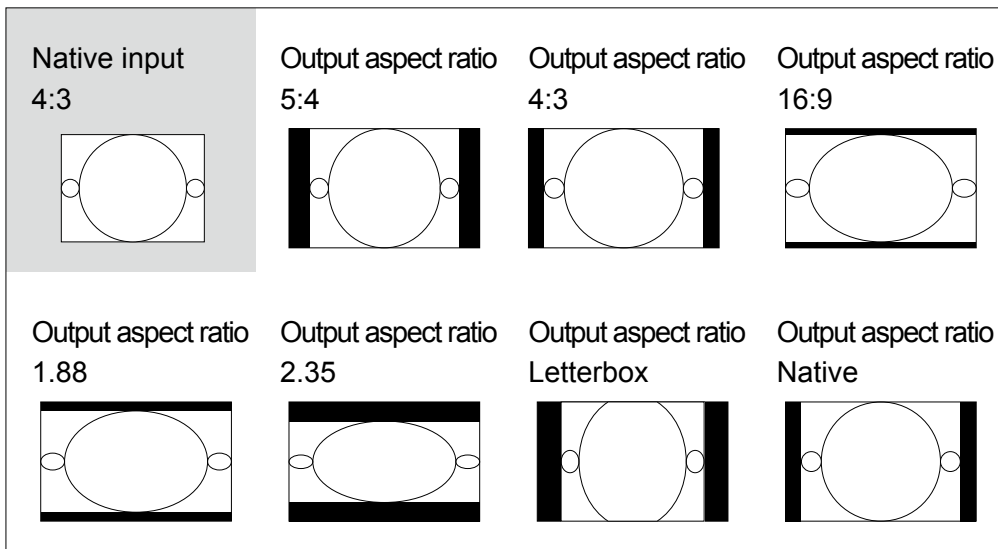

Cropped portion of the image



that when used for commercial purposes, including: projection of image in movie theatres, hotels, cafeteria and other public venues, compression or extension of image achieved through the change of aspect ratio may constitute copyright infringement to the rightful owner of the image. Please do so at your own discretion.

8.9 Timings

H Total

Press ◀▶ to adjust the horizontal total.

Use this function to adjust the clock frequency of pixel sampling (horizontal pixel frequency of the analog input source generated by the ADC). If you notice flickering or verticle lines in the image, it means that the pixel sampling frequency is insufficient. You can use this function to adjust the frequency to achieve consistent image quality.

The following image is an example of test image from an external signal source:



Adjust image quality by changing the value of horizontal total to smoothen the image.

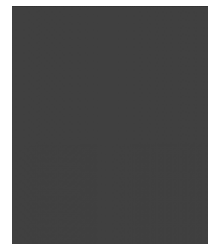

In order to adjust timings the pattern should be used is pixel (on/off)

H Start

Use ◀▶ to adjust the projected image's horizontal position.

If the projected image is not at the center of the screen (i.e. shifted to right or left) and ends up being cropped, use this function to adjust the image's horizontal position. The following image is an example of test image from an external signal source:

Native picture

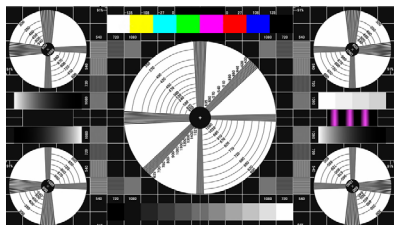

Skewed left

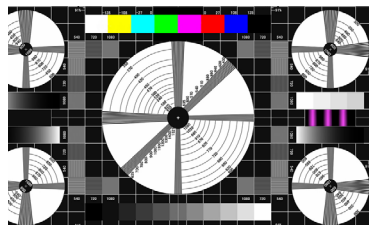

Skewed right

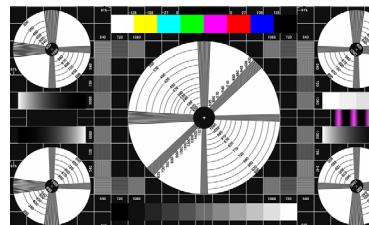

V Phase

Use ◀▶ to adjust the projected image's phase.

Use this function to adjust the phase of pixel sampling clock (relative to input signal). Should the image still flicker or show noise (i.e. edges on texts) after optimization, adjust phase accordingly.

V Start

Use ◀▶ to adjust the projected image's vertical position.

If the projected image is not at the center of the screen (i.e. shifted up or down) and ends up being cropped, use this function to adjust the image's vertical position. The following image is an example of test image from an external signal source:

Native picture

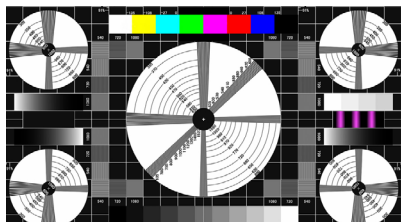

Skewed down

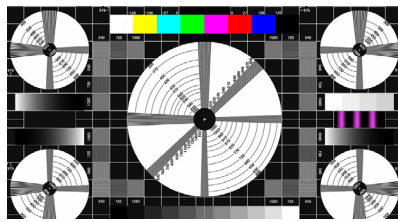

Skewed Up

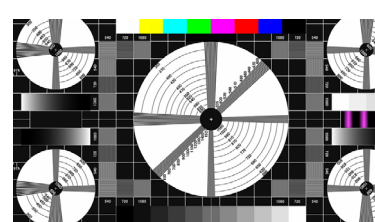

It is recommended that when adjusting the image, the horizontal total should be adjusted before the horizontal phase. However, if the image still flickers even after you have adjusted both, try lowering the image noise.

8.10 Auto Image

When Auto Image was selected in the Advanced menu, press **OK** to execute the automatic image adjustment function.

By executing this function, the projector will resync the image. Use this function when the image source is unstable or when you notice deterioration in image quality and the projector will automatically adjust the image size, phase and timing. (The adjustment also applies to PIP input source).

9. LAYOUT

Overview

- Layout menu overview
- Zoom
- Main Select
- PIP Select
- PIP Position
- PIP

9.1 Layout menu overview

LAYOUT	Zoom	Off Crop Zoom
	Main Select	HDMI1 HDMI2 VGA YUV1 RGBHV/YUV2
	PIP Select	HDMI1 HDMI2 VGA YUV1 RGBHV/YUV2
	PIP Position	Top Left Top Right Botton Left Botton Right Split L-R
	PIP	On, Off

BARCO PJWU-101B		INPUT	IMAGE	LAYOUT	LAMPS	ALIGNMENT	CONTROL	SERVICE
				Zoom		< Zoom >		
				Main Select		Enter		
				PIP Select		Enter		
				PIP Position		< Split L-R >		
				PIP		< Off >		

9.2 Zoom

Due to the fact that some consumers may still be using older television systems, some TV programs may not display the edges of the image. Use this function to hide the image edge by choosing one of the following three options:

- Off
Setting it to off makes no change to the projected image.
- Crop
Setting it to "Crop" will add two "masks" equivalent to 3% of horizontal resolution on either side of the image and two similar masks above and below the projected image.
- Zoom
You can use this function to enlarge the image's horizontal resolution over the 106% of the default aspect ratio. Any portion that exceeds the original image will be cropped.

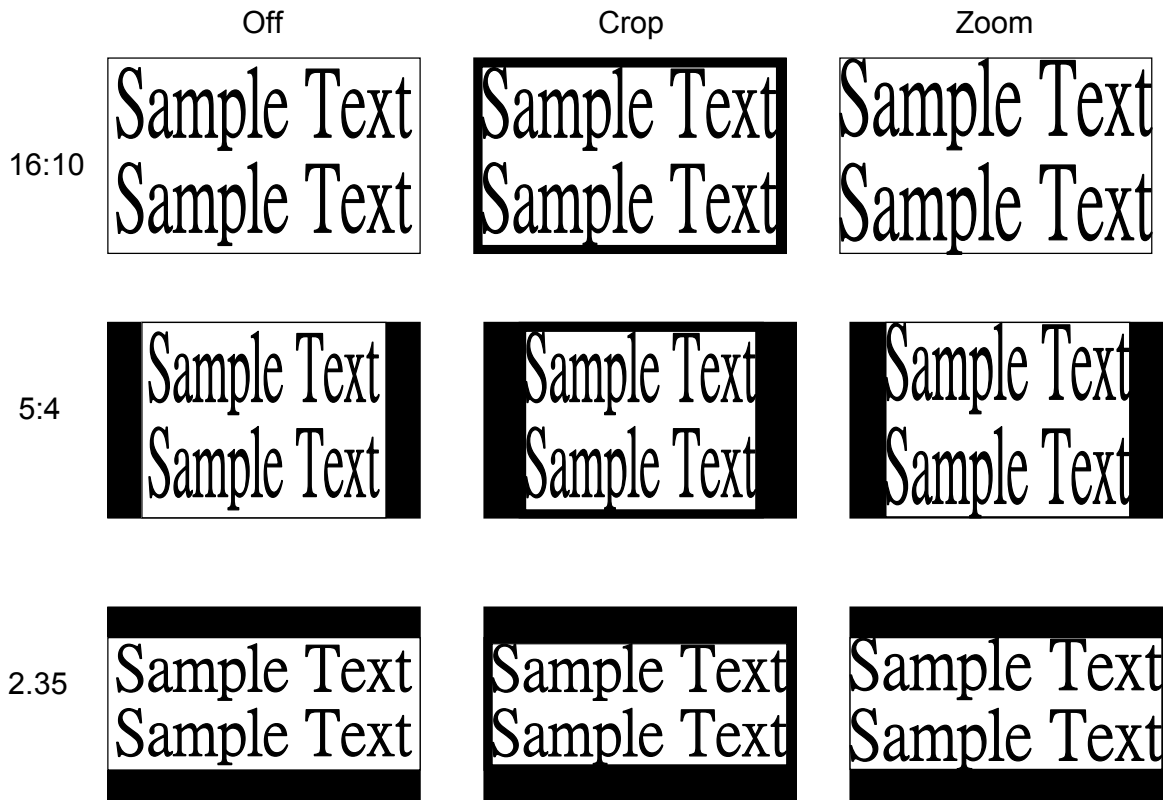

When you set aspect ratio to "Native", be sure to set Zoom to "Off" or "Crop".

9.3 Main Select

When you want to project PIP image, use this function to specify the image source for the PIP image. This function is identical to Input Selection; for more information, please refer to [page 38: 7.2 Input Selection](#)

9.4 PIP Select

Use this function to select the source for the sub window. You can choose from HDMI1, HDMI2, VGA, YUV1, RGBHV/YUV2.

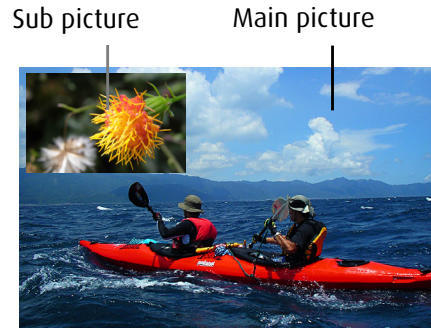

PIP stands for "Picture in Picture" and allows to display multiple windows containing each of them an image. The windows may be of the video or data type.

9.5 PIP Position

You can choose to display the sub window in five different location over the main picture according to your preference.

Top Left



Top Right



Split L-R



Bottom Left



Bottom Right



9.6 PIP

If you wish to display PIP image, you can make the configuration here. By choosing "ON", you will see two windows on the projected image; the larger one is the primary image and the smaller one is the sub image. By choosing "OFF", the PIP function will be disabled and you will only see a single image window.

Refer to the following main and PIP source matrix for a valid main and PIP source selection when PIP is ON.

Pip/main source availability		Main select				
		HDMI1	HDMI2	VGA	YUV1	RGBHV/YUV2
PIP select	HDMI1		-	●	●	●
	HDMI2	-		●	●	●
	VGA	●	●		-	-
	YUV1	●	●	-		-
	RGBHV/YUV2	●	●	-	-	

● Source available - source not available

10. LAMP

Overview

- Lamp menu overview
- Lamps Single and Dual setup
- High Altitude Mode setup
- Power saving setup
- Lamp1 and Lamp2 on or off setup
- Lamp1 and Lamp2 Run Time display
- Lamp Performance

10.1 Lamp menu overview

LAMPS	Mode	Eco Normal Power
	LAMPS	Single Dual
	High Altitude Mode	On Off
	Power	77.3% - 100%
	Lamp1 Status	On Off
	Lamp2 Status	On Off
	Lamp1 Run Time	XX HRS
	Lamp2 Run Time	XX HRS

BARCO PJWU-101B						
INPUT	IMAGE	LAYOUT	LAMPS	ALIGNMENT	CONTROL	SERVICE
			Mode		< Power >	
			Lamps		< Dual >	
			High Altitude Mode		< Off >	
			Power		< 91.4 % >	
			Lamp1 Status :		Off	
			Lamp2 Status :		Off	
			Lamp1 Run Time :		100HRS	
			Lamp2 Run Time :		100HRS	

10.2 Mode

This chapter covers information on the projector lamp.

Mode

When the lamp is set to ECO mode, the lamp is running at 360W. If the ambient temperature is higher than 35 degree Celsius, lamp will operate at ECO mode. In this case, lamp mode selection is unavailable. Lamp mode selection is available once the ambient temperature drops below 35 degree Celsius.

- **ECO**
When set to Eco mode, the wattage of the lamp will be at 360W. If the surrounding environment is sufficiently dark or if you do not require intense brightness, you can set the lamp to Eco mode to prolong its usage life.
- **Normal**
When set to Normal mode, the wattage of the lamp will be at 465W. If the projection environment requires brighter image, you can set the lamp to Normal for the highest projection brightness.
- **Power**
If the image brightness at Eco mode is too dark for you and the Normal mode gets too bright, you can set it to Power to specify the power of the lamp yourself to make fine adjustments to the brightness of the projected image. you could encounter situations where the image from projector A being brighter than projector B. When this occurs, you can use this function you could encounter situations where the image from projector A being brighter than projector B. When this occurs, you can use this function to fine tune the brightness of the two projectors to achieve consistent image brightness. To access this function, go to the Advanced Menu → LAMPS → Power and adjust accordingly.

10.3 Lamps

Depending on the application condition, either single lamp or dual lamps can be selected via Advanced menu. When the projector was switched from single lamp to dual lamps, an hourglass OSD will block the user from the further OSD operation for 7 seconds. When the projector was switched from dual lamp mode to single lamp, the lamps selection OSD will be blocked for 90 seconds for lamp cooling. The lamp power can be adjusted from 77.3% ~ 100%.

- **Single**
When the projection environment is sufficiently dark that a single lamp could achieve the desired projection brightness, you can choose to use one single lamp. The projector will automatically determine the usage hours for lamp1 and lamp2 and choose the lamp with lower hours for the operation.
- **Dual**
When you require brighter image from the projector, please operate the projector with Dual lamps.

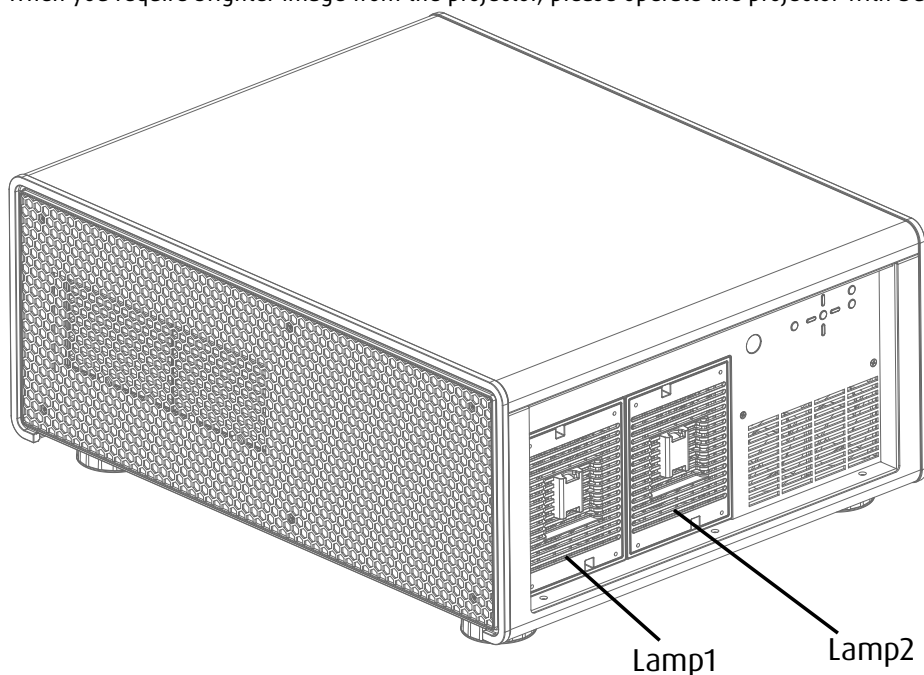

10.4 High Altitude Mode

Use this function to control the projector's cooling fan. You can set it to Off or On. The default setting is Off.

Under normal circumstances, the projector will operate normally with this function set to Off. By default, the projector will detect the temperature of the surrounding environment to regulate the speed of the cooling fan. When the ambient temperature rises, fan speed will increase (generates louder noise) to make sure the heat inside the projector gets discharged and keep the projector working normally.

However, if you were to operate the projector in environment of excessive heat or in areas of high altitude, the projector may automatically shut down. When this happens, you can enable this function by setting it to On to force the cooling fan to work at a higher speed to regulate the temperature inside the projector.

- High altitude region refers to area with elevation over 1500 meters (4900 feet).
- When operating in normal altitude environments, the projector will adjust the cooling fan according to the temperature of the working environment. When the temperature rises above 30C, the projector will automatically increase fan speed.
- According to the product specification, the maximum operating altitude for the projector is at 3000m@25C. This means that you should not be operating the projector in high altitudes when the working environment is over 25C. (Due to the air thinning substantially at high altitudes, the result of cooling achieved by the cooling fan is significantly reduced compared to operation on level ground. With low atmospheric pressure and high operating temperature, the cooling fan will not be able to disperse the heat adequately)

10.5 Power

This function will not be available if you have set the lamp to Eco or Normal modes, refer to [page 52: Mode](#), you can only adjust this setting when the lamp has been set to "Power". You can specify the lamp power in the range of 85% ~ 91.4%. Generally speaking, the lower the power, the dimmer the image will be but the lamp will have longer lifecycle. In contrast, the higher the power, the brighter the image will be at the cost of shorter lamp lifecycle.

10.6 Lamp1 Status

This function is limited to display purposes to inform the user of Lamp1 status (On or Off).

10.7 Lamp2 Status

This function is limited to display purposes to inform the user of Lamp2 status (On or Off).

10.8 Lamp1 Run Time

This function is limited to display purposes to inform the user of Lamp1's total run time.

10.9 Lamp2 Run Time

This function is limited to display purposes to inform the user of Lamp2's total run time.

10.10 Lamp Performance

It is suggested that the projector should stay a runtime at least 30 minutes or longer to ensure the Lamp Performance.

11. ALIGNMENT

Overview

- Alignment menu overview
- Adjusting screen orientation(Rear Projection, Ceiling Mode on of off setup)
- Lens Control for zoom, focus and V/H Shift setup
- Keystone adjustment
- Dynamic Contrast setup
- Gammy adjustment
- Internal Patterns setup
- Color space select
- Setup lens to midposition

11.1 Alignment menu overview

ALIGNMENT	Rear Projection	On Off
	Ceiling Mode	On Off
	Lens Control	Zoom Focus Shift V/H
	Keystone	Enter
	Dynamic Contrast	On Off
	Gamma	1.8 2.0 2.2 2.35 2.5 S-Curve
	Internal Patterns	On Off
	Color Space	Native Custom
	Lens To Midposition	Execute

BARCO PJWU-101B						
INPUT	IMAGE	LAYOUT	LAMPS	ALIGNMENT	CONTROL	SERVICE
				Rear Projection	< Off >	
				Ceiling Mode	< Off >	
				Lens Control	Enter	
				Keystone Adjust	Enter	
				Dynamic Contrast	< Off >	
				Gamma	< 2.5 >	
				Internal Patterns	Enter	
				Color Space	< Custom >	
				Lens To Midposition	Execute	

11.2 Adjusting screen orientation

By default, the projector is configured for “frontal projection - desktop installation”. If you choose to install your projector in other setups, be sure to adjust the screen orientation to achieve the correct projection mode.

Front projection - ceiling mode

Press **HOME** → **Advanced** → **ALIGNMENT** → **Ceiling Mode** and choose **ON**; the projector is now configured for “frontal projection - ceiling mode”.

Correct Picture

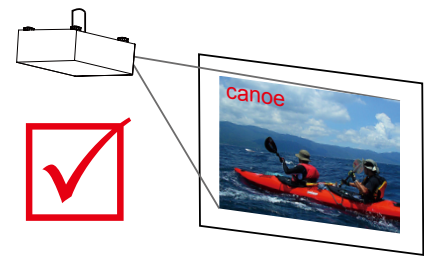
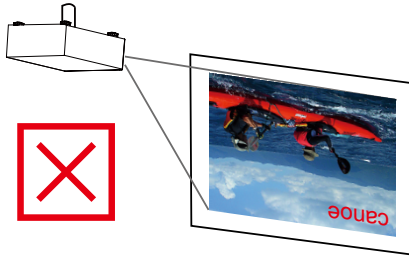

Rear projection - desktop installation

Press **HOME** → **Advanced** → **ALIGNMENT** → **Rear Projection** and choose **ON**; the projector is now configured for “rear projection - desktop installation”.

Correct Picture

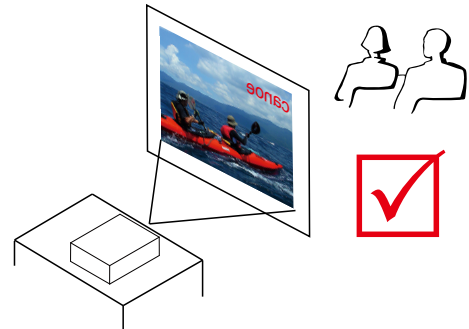
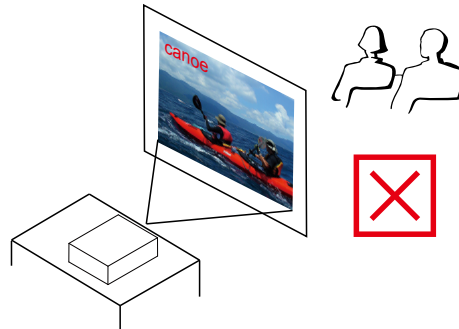

Rear projection - ceiling mode

Press **HOME** → **Advanced** → **ALIGNMENT** → **Rear Projection** and choose **ON**;

press **HOME** once more → **Advanced** → **ALIGNMENT** → **Ceiling Mode** and choose **ON**

Correct Picture

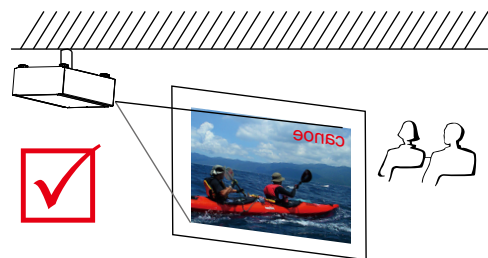
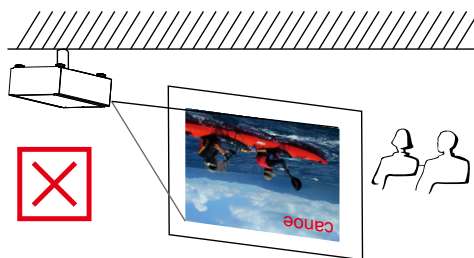

11.3 Rear Projection

The default of the Rear Projection setting is Off.

See 11.2 Adjusting screen orientation, refer to [page 55: 11.2 Adjusting screen orientation](#)

11.4 Ceiling Mode

The default setting is Off.

When you have set up the projector for ceiling mode (hung from the ceiling in reverse), please set it to ON. Refer to [page 55: 11.2 Adjusting screen orientation](#)

11.5 Lens Control

Zoom

Use this function to zoom in or zoom out the image size. Refer to [page 15: Lens zoom](#).

Focus

Use this function to adjust the image Focus. Refer to [page 15: Lens focus](#)

Shift

Use this function to adjust the lens shift. Refer to [page 16: Lens Shift](#).

11.6 Keystone

Horizontal Keystone & Vertical Keystone

Use this function to correct keystoneing caused by projection angle.



The summation of the absolute value of horizontal keystone and vertical keystone is limited to less than or equal to 35°.

11.7 Dynamic Contrast

Use this function to configure the projector to automatically adjust image contrast from the source upon start up or shut down. When activated, the projector will dynamically adjust the image contrast from the beginning of the projection until the content has ended.

11.8 Gamma

Different Gamma settings will affect viewers' perception of the image. Generally speaking, for images that are darker, it is recommended that Gamma be set higher to yield better image quality in darker regions by sacrificing details in brighter areas. In contrast, when projecting brighter images, you can set the Gamma lower to give up details in the darker areas to make the brighter areas (i.e. clouds) more visible.

You can choose from five different gamma settings (1.8, 2.0, 2.2, 2.35 , 2.5 and S-curve) on the projector. The projector's default gamma value is at S-Curve.

Every setting has precisely defined phases to display all primary colors (red, green, blue) and secondary colors (yellow, cyan, magenta) in millions of pixels. Changing any number in the setting will change the resulting color and rearrange the color "triangle".

11.9 Internal Patterns

The projector comes with some standard built-in patterns for testers to calibrate the equipment. These include:

0 = Off	7 = White
1 = Color Bars	8 = Black
2 = Hatch	9 = TI-Red
3 = Burst	10 = TI-Green
4 = Red	11 = TI-Blue
5 = Green	12 = TI-Ramp
6 = Blue	

11.10 Color Space

Using different color space will create different color presentation in the projected image. You can choose from the following color gamma:

Native

Choose this to apply the projector's native color gamut

Custom

Choose this to customize the color gamut according to your preference through projector Toolset application.

11.11 Lens To Midposition

After series of lens shift operations, this function can be used to return the lens to the center position.

12. CONTROL

Overview

- Control menu overview
- ECO Network Power setup
- Network address setup
- OSD Menu position
- Projector start up display Logo or not
- Projector start up Chime on or off
- Setup the trigger
- Setup the projector auto select the source or not
- Setup the Advanced menu's language

12.1 Control menu overview

CONTROL	Eco Network Power	On Off
	Network	IP Address Subnet mask Gateway DHCP
	Menu Position	Top Left Top Right Bottom Left Bottom Right Center
	Start Up Logo	On Off
	Start Up Chime	On Off
	Trigger 1	5:4 4:3 16:10 16:9
	Trigger 2	1.88 2.35 Letterbox Native Auto
	Auto Source	On Off
	Language	English French Spanish German Chinese Simplified Japanese Korean Russian Turkish

BARCO PJWU-101B		INPUT	IMAGE	LAYOUT	LAMPS	ALIGNMENT	CONTROL	SERVICE
					Eco Network Power	<	Off	>
					Network		Enter	
					Menu Position	<	Center	>
					Start Up Logo	<	Off	>
					Start Up Chime	<	Off	>
					Trigger 1	<	Unscaled	>
					Trigger 2	<	Unscaled	>
					Auto Source	<	Off	>
					Language		Enter	

12.2 Eco Network Power

The projector can be connected to a network via its RS-232 port and 10/100 BASE-T port for remote operation with two separate boards to control the signal sources from RS-232 and 10/100BASE-T ports.

If you do not require remote operation of the projector over a network, it is recommended that you set this function to On to activate the ECO Network Power. This will turn off the power that is used to control the 10/100 BASE-T board. However, you will not be able to operate the projector remotely over a network as long as the function remains activated.

By setting it to Off, the function will be disabled. You won't be able to conserve power but you can control the projector remotely over a network.

12.3 Network

To control the projector via network, after connecting the network cables for a PC and the projector, you can use this OSD function to view the relevant network information (such as IP Address, Subnet Mask, Gateway and DHCP) of the projector. Please configure the PC to be connected to the projector with a proper IP address with the same subnet mask, gateway as the projector. The default IP address of the projector is 192.168.0.100. The network settings of the projector can only be changed through the web-page control or projector Toolset application.

To control the projector via network, please connect to the projector via a web browser with the IP address shown on the Advanced menu CONTROL → Network. The home page will be displayed as follows.

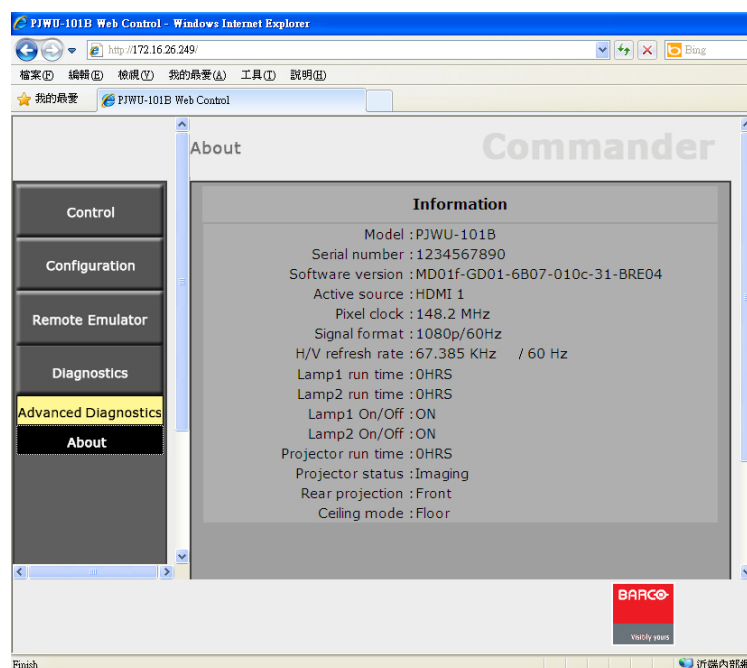

IP Address

Internet Protocol. The network layer of TCP/IP. Required for communication with the internet.



Can only be used with a wireless network module installed.

Subnet mask

A number that is used to identify a subnetwork so that IP addresses can be shared on a local area network.



Can only be used with a wireless network module installed.



Subnet for Wired and Wifi must be different !

Gateway

A router that serves as an entry point into and exit point out of a network. For example, a local network (LAN) may need a gateway to connect it to a wide area network (WAN) or to the Internet.



Can only be used with a wireless network module installed.

HDCP

Dynamic host configuration protocol. DHCP is a communications protocol that lets network administrators manage centrally and automate the assignment of IP addresses in an organization's network. Using the Internet Protocol, each machine that can connect to the Internet needs a unique IP address. When an organization sets up its computer users with a connection to the Internet, an IP address must be assigned to each machine. Without DHCP, the IP address must be entered manually at each computer and, if computers move to another location in another part of the network, a new IP address must be entered. DHCP lets a network administrator supervise and distribute IP addresses from a central point and automatically sends a new IP address when a computer is plugged into a different place in the network.



Can only be used with a wireless network module installed.

12.4 Menu Position

You can use this function to designate which area on the image the OSD Menu will appear.

As you can see from the diagram below, there are five positions where you can choose to have the OSD Menu displayed. The default setting is "Center".

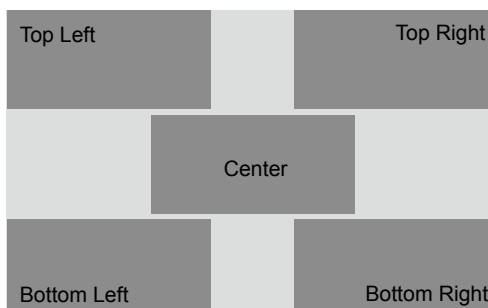

12.5 Start Up Logo

You can use this function to have the projector display the Barco logo in the start up screen. Set **On** to display the Barco logo during start up and **Off** to display a blank image.

12.6 Start Up Chime

Set it to On to have the projector play a sound effect during start up; when it is set to off, the projector will not play any sound effect to indicate start up.

12.7 Trigger1 ~2

The projector comes with two sets of Trigger output. You can configure two different devices connected to the projector via the trigger ports to be automatically turned on when the projector is on. There will be a 2-3 second delay prior to activation to prevent operation of this function when the user is choosing the desired aspect ratio.

5:4	Outputs 12V of power on Trigger1 or 2 when the user chooses the 5:4 aspect ratio.
4:3	Outputs 12V of power on Trigger1 or 2 when the user chooses the 4:3 aspect ratio.
16:10	Outputs 12V of power on Trigger1 or 2 when the user chooses the 16:10 aspect ratio.
16:9	Outputs 12V of power on Trigger1 or 2 when the user chooses the 16:9 aspect ratio.
1.88	Outputs 12V of power on Trigger1 or 2 when the user chooses the 1.88 aspect ratio.
2.35	Outputs 12V of power on Trigger1 or 2 when the user chooses the 2.35 aspect ratio.
Letterbox	Outputs 12V of power on Trigger1 or 2 when the user chooses the Letterbox aspect ratio.
Native	Outputs 12V of power on Trigger1 or 2 when the user chooses the native aspect ratio.
Auto	Outputs 12V of power on Trigger 1 or 2 when the projector is turned on.

12.8 Auto Source

ON

default setting. By enabling this function, the projector will automatically determine the source of input every time it is turned on so that the user will not have to make the selection on the OSD Menu.

OFF

Setting the function off will require the user to specify source of image input on the OSD Menu in order for the projector to display the intended image.

12.9 Language

The user can change the language of the on screen menus and the local display menus to one of the available languages.

You can choose from the following nine languages: English, French, Spanish, German, Simplified Chinese, Japanese, Korean, Russian and Turkish.

13. SERVICE

Overview

- Service menu overview
- Use this function to display the projector's message.

13.1 Service menu overview

SERVICE	Model	Read-only information
	Serial Number	
	Software Version	
	Active/PIP source	
	Pixel Clock	
	Signal Format	
	H/V Refresh Rate	
	Lamp1 Run Time	
	Lamp2 Run Time	
	Lamp Hour Reset	Lamp1 Hour Reset Lamp2 Hour Reset
	Projector Run Time	Read-only information
	Blue Only	On Off
	Factory Reset	The command will be executed after confirmation in the prompt dialog box

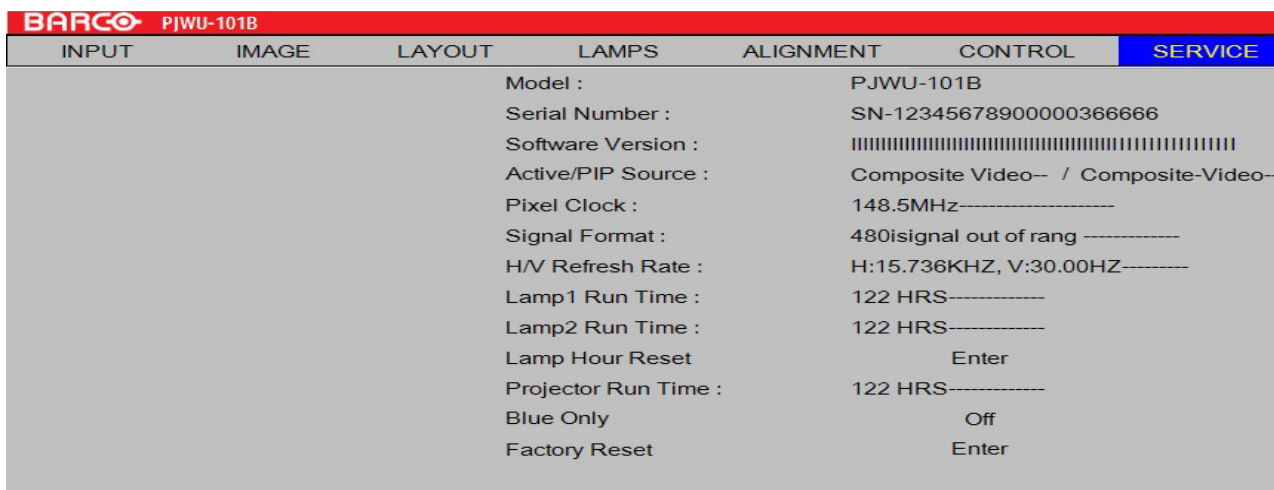

13.2 Service message of the projector

The functions covered in this unit relate to the display of some basic information about the projector.



Memory of the custom timing files will be erased in the Factory Reset operation

- Model: the designated model number of the projector.
- Serial Number: the designated serial number of the projector.
- Software Version: the version of software installed on the projector.
- Active/PIP Source: displays the current PIP sources.
- Pixel Clock: displays the pixel clock of the current input signal.
- Signal Format: displays the format of the current input signal.
- H/V Refresh Rate: displays the horizontal and vertical refresh rates for the current image.
- Lamp1 Run Time: displays Lamp1's current run time.
- Lamp2 Run Time: displays Lamp2's current run time.
- Projector Run Time: displays the projector's total operating hours.



When a lamp's run time has reached 1200 hours or when you notice the projected image to be noticeably dimmer, please replace the lamp

13.3 Lamp Hour Reset

Use this function to reset the hours for lamp1 and lamp2 to zero.



After replacing the lamp, remember to reset the lamp hours to ensure the accuracy of lamp hours displayed in the OSD Menu.

13.4 Blue Only

Enabling this option will make the projector display only blue color to facilitate the process of image inspection for the service personnel. For detailed instructions on how to use this function, consult a qualified service personnel.

13.5 Factory Reset

All settings of the projector will be set to the original factory settings. All user settings are erased with this operation.



This function will not apply to items including no signal, network, Projector control, startup Logo, language, High Altitude mode and lamp hours



When Factory Reset is executed, all source memories created by the projector (i.e. timings files) will be erased

14. MAINTENANCE

14.1 Lamp Replacement

The lifecycle of ordinary projection lamp typically lasts for 1500 hours before requiring replacement (different lamp configurations will affect lamp life). From the OSD Menu, you can go to " [page 53: 10.8 Lamp1 Run Time](#) ". to check how long a lamp has been used. You should also replace the lamp when the projected image gets noticeably darker. Contact your local dealer to purchase new certified lamps for your projector.



WARNING: This procedure may only be performed by qualified technical service personnel.

How to replace the projector lamp

WARNING: Switch off the projector and unplug the power cord before starting the procedure.



Keep all flammable items away from lamp

Never to remodel or disassembly on lamp housing

Lamp contains mercury. If lamp bursts during operation. Keep yourself in sufficiently ventilate area in order to avoid inhaling mercury.

1. Turn off the projector and unplug the power cord. Let the projector cool for approximately 60 minutes before removing the lamp module for replacement.



When you turn off the projector, the lamp inside the projector will still be very hot (approximately 200 ~ 300°C). If you attempt to replace the lamp without allowing the projector to cool, you could risk scalding yourself. This is why you should wait for no less than 60 minutes for the lamp to cool down in order to perform the replacement safely.

2. Loosen the lamp cover.

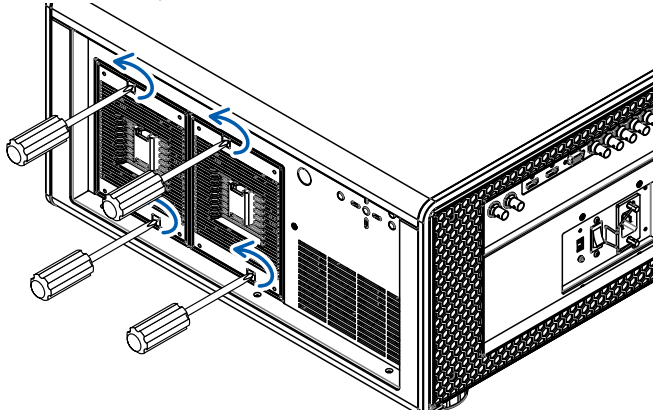

3. Take out the lamp cover.

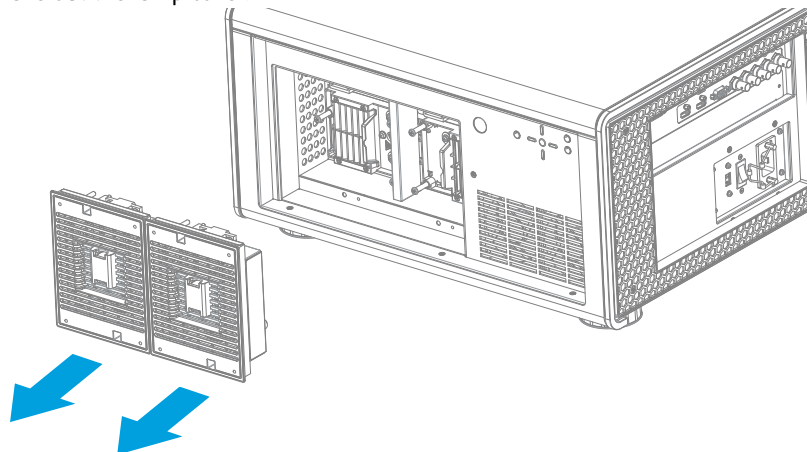

4. Use a screw driver to loosen the screws as shown in the illustration.

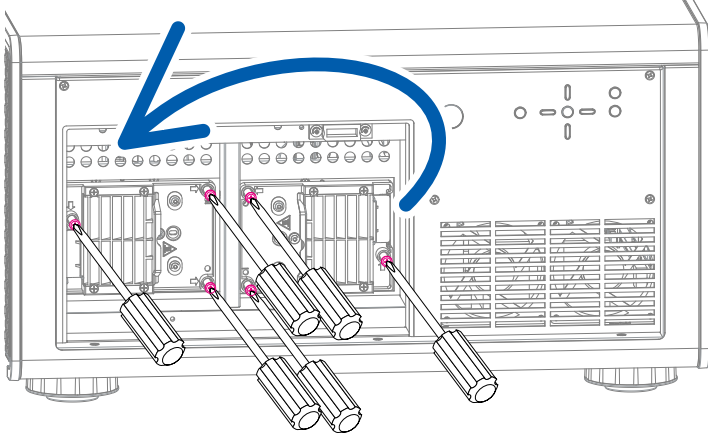

5. Pull the lamp out.

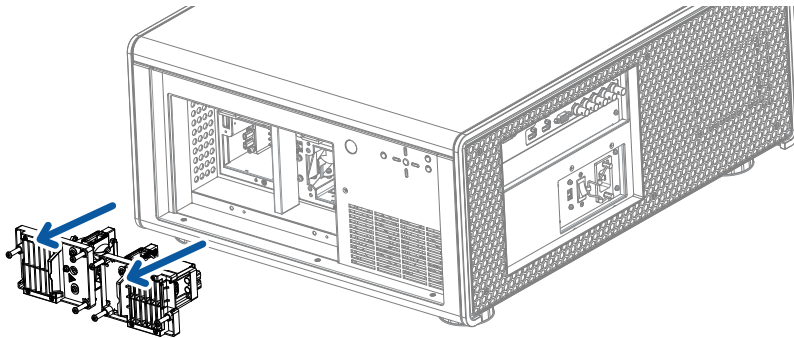

6. Insert the new lamp in the direction shown in the illustration into the lamp assembly; tighten the two screws using a screw driver and make sure the lamp is firmly secured to prevent the lamp from shaking or poor contact.

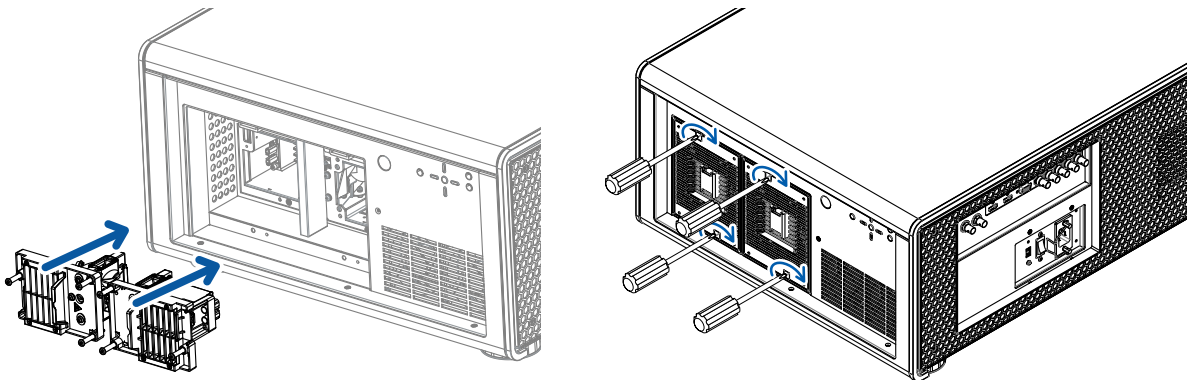

7. Replace the lamp cover and firmly secure the four screws on the lamp cover.

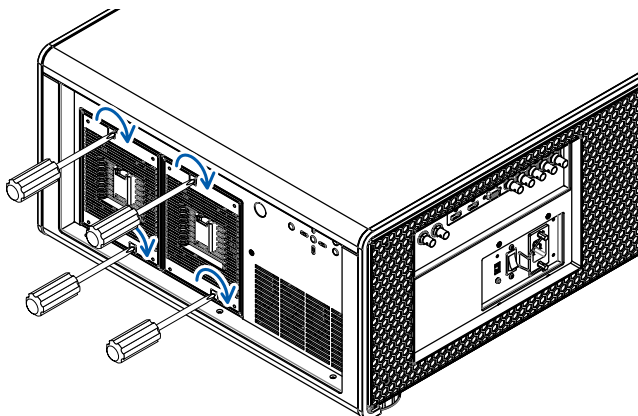

8. Reconnect power to the projector and reset the lamp usage timer. Refer to [page 53: 10.8 Lamp1 Run Time](#) and [page 53: 10.9 Lamp2 Run Time](#)



While starting up the projector, the electronics detect if a lamp is installed. If no lamp is installed, it is not possible to start up the projector.

14.2 Replace the filter (for inlet *Ventilation*)

Make sure to replace the filter when it is required to keep the air intake clear of dust, and prevent possible over temperature issue of the projector due to the clog of filter.



CAUTION: The high density filter must be replaced on a regular basis, depending on the environment conditions of the projector. Suggest to replace filter every 500 hours runtime.



WARNING: Switch off the projector and unplug the power cord before starting the procedure.



CAUTION: Never use the projector with removed filters !

Necessary parts

New filter (available kit : R9899730, contains 4 high density filters)



CAUTION: Never clean the filter Always replace with a new one.

How to change the filter in the Right side.

1. Loosen the six screws on the projector right side cover.

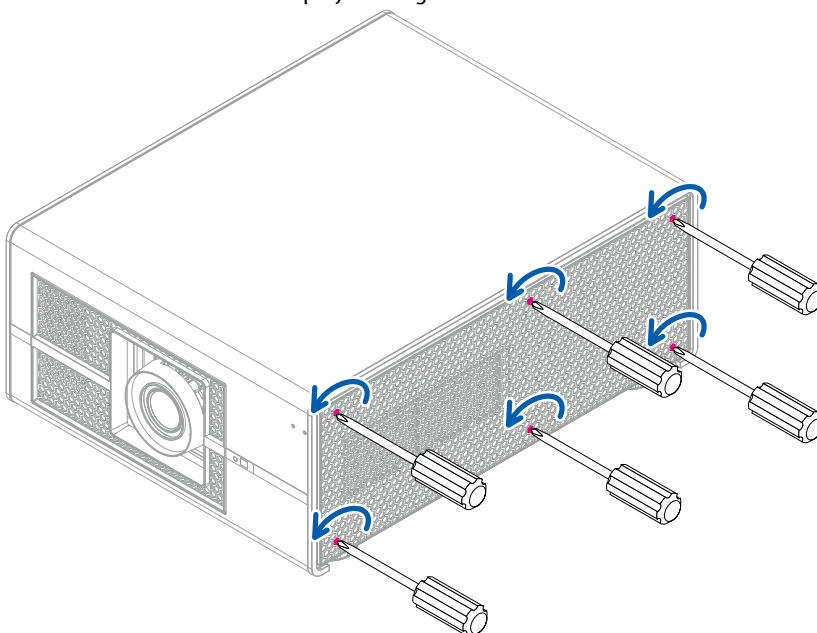

2. Take out the old filter.

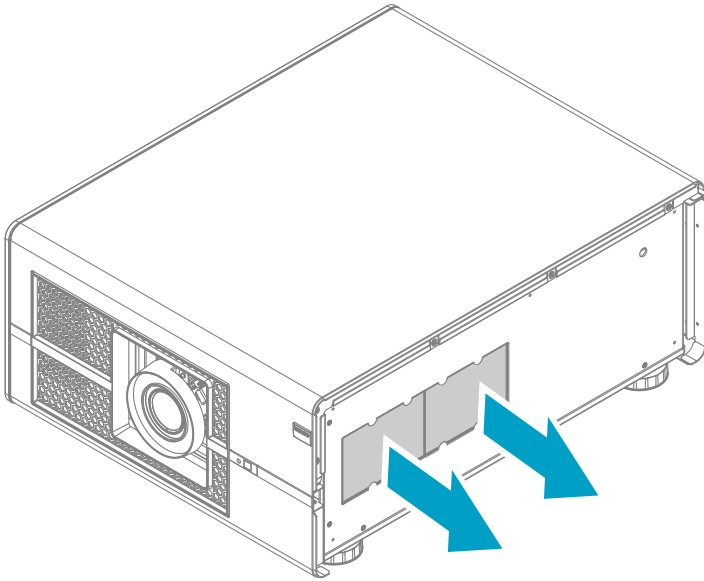

3. Insert new filter.

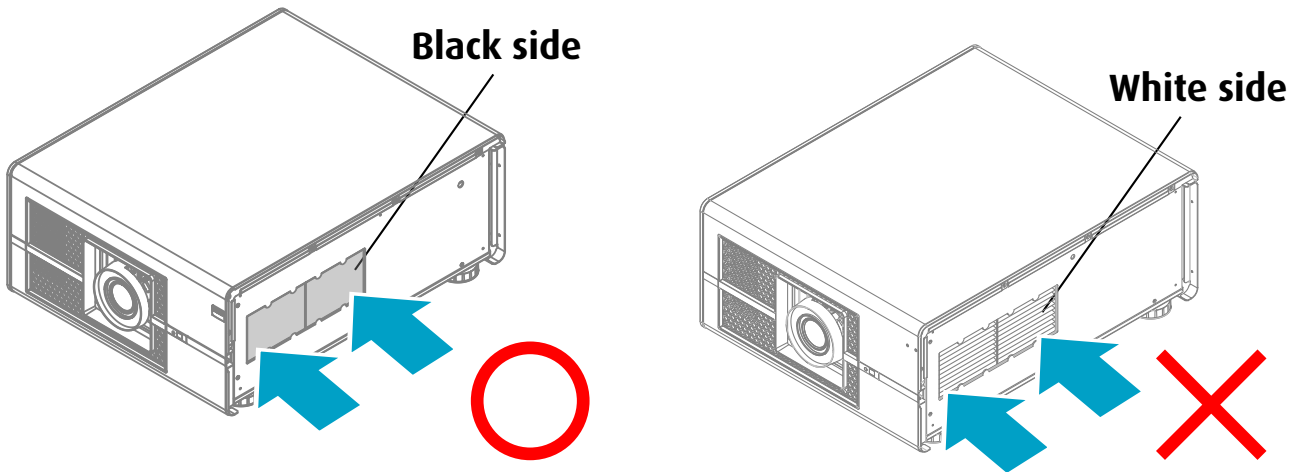

4. Tighten the six screws of right side cover.

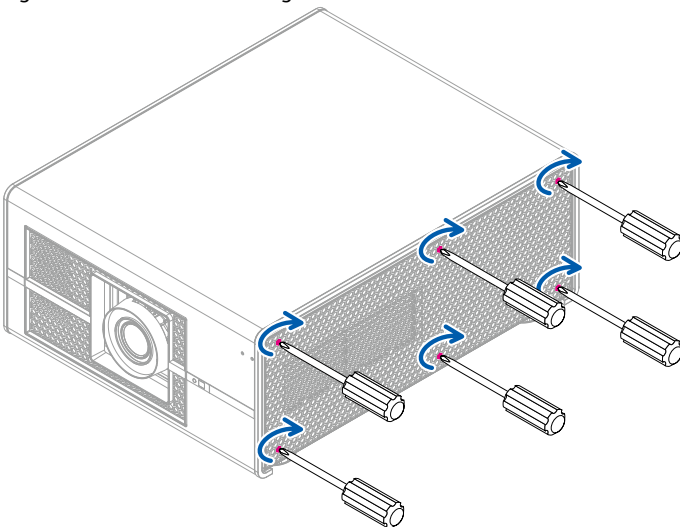

How to change the filter in the Left and Front side.

1. Loosen the six screws on the projector left side cover.

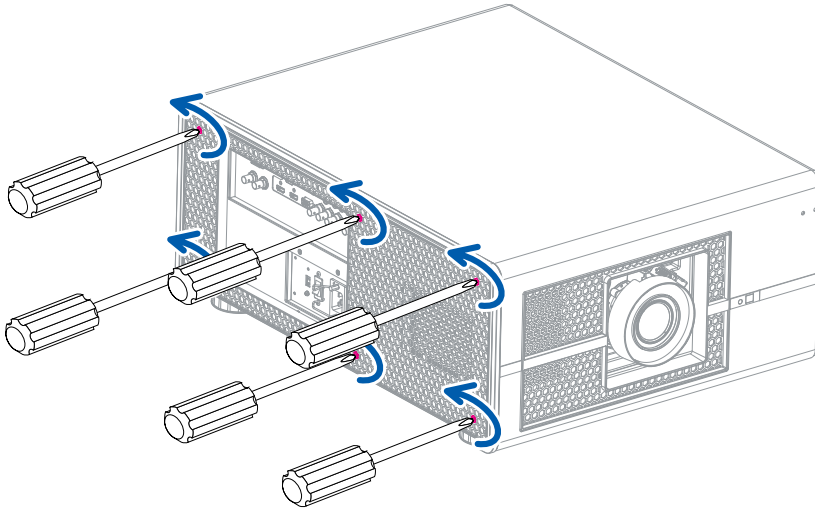

2. Take out the old filter(left and front).

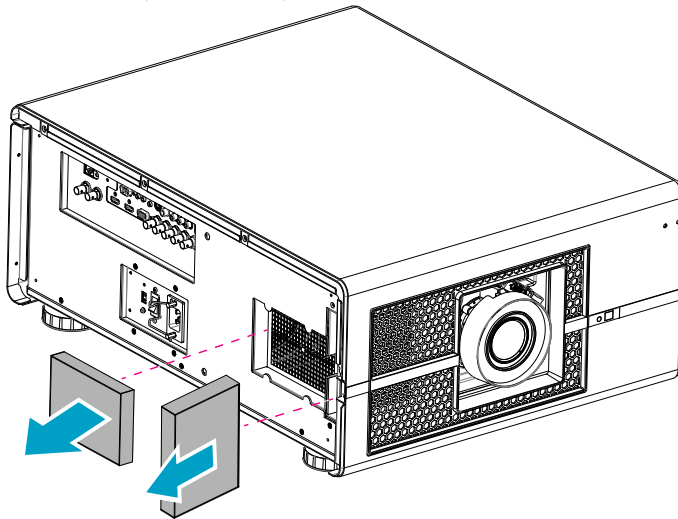

3. Insert new filter.

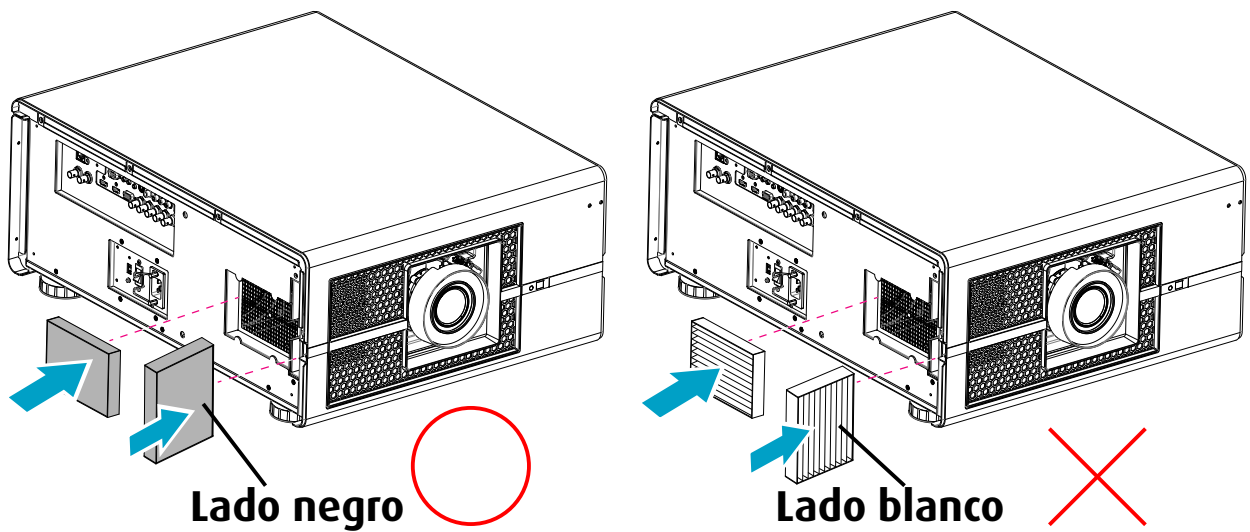

4. Tighten the six screws of left side cover.

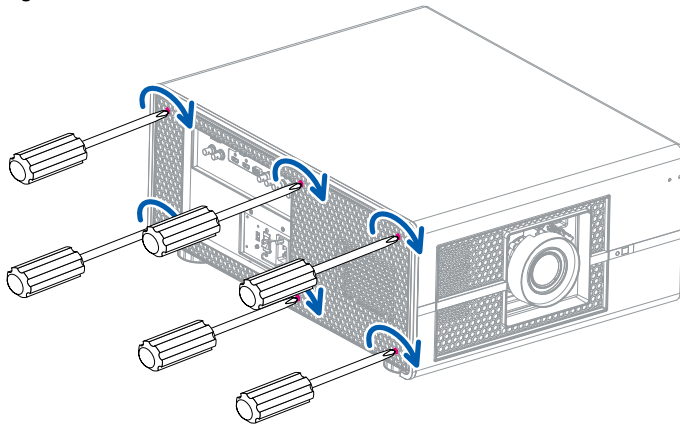

14.3 Clean the dust filter(for outlet Ventilation)

1. Remove most contamination with a vacuum cleaner.
2. Blow remaining dust away with compressed air in an other room or outside.

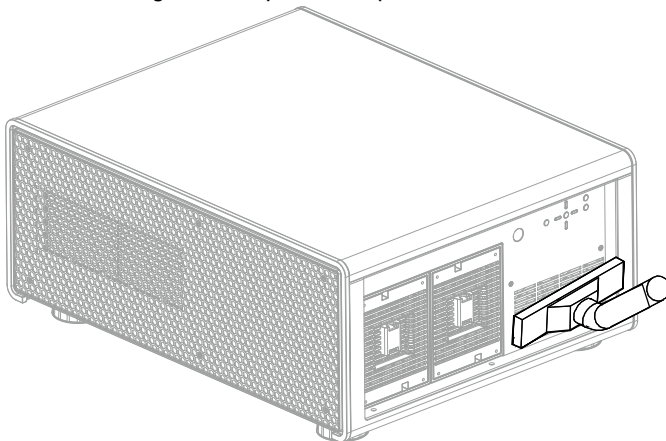

14.4 Cleaning the lens



To minimize the possibility of damage to optical coatings, or scratches to lens surfaces, we have developed recommendations for cleaning. **FIRST**, we recommend you try to remove any material from the lens by blowing it off with clean, dry deionized air. **DO NOT** use any liquid to clean the lenses.

Necessary tools

Toraysee™ cloth (delivered together with the lens kit). Order number : R379058.

How to clean the lens ?

3. Always wipe lenses with a CLEAN Toraysee™ cloth.
4. Wipe lenses in a one single direction.
Warning: Do not wipe back and forwards across the lens surface as this tends to grind dirt into the coating.
5. Do not leave the cleaning cloth in either an open room or lab coat pocket, as doing so can contaminate the cloth.
6. If smears occur when cleaning lenses, replace the cloth. Smears are the first indication of a dirty cloth.



CAUTION: Do not use fabric softener when washing the cleaning cloth or softener sheets when drying the cloth.

Do not use liquid cleaners on the cloth as doing so will contaminate the cloth.



Other lenses can also be cleaned safely with this Toraysee™ cloth.

14.5 Cleaning the exterior of the projector

How to clean the exterior of the projector ?

1. Switch off the projector and unplug the projector from the mains power net.
2. Clean the housing of the projector with a damp cloth. Stubborn stains may be removed with a cloth lightly dampened with a mild detergent solution.

14.6 Simple troubleshooting

The following table offers a list of common problems with projectors and how to troubleshoot. If the recommended solutions fail to resolve your problem, contact your local dealer to arrange for servicing; do not attempt to service the projector by yourself.

Problem	Possible cause	Solution
You cannot turn on the projector	<ol style="list-style-type: none"> 1. The projector may be unplugged 2. Check the AC POWER SWITCH on the back of the projector and see if it is flipped to ON. 3. The AC socket may be faulty 4. The lens cover is not replaced properly 	<ol style="list-style-type: none"> 1. Plug the projector's power cord into a wall outlet 2. Flip the power switch to "I". 3. Make sure the AC socket is working properly. 4. Make sure the lens cover has been properly replaced.
You cannot turn on the projector after turning it off	<ol style="list-style-type: none"> 1. You will not be able to turn on the projector within two minutes after you have just turned it off. This feature is designed to protect the lamp. 	<ol style="list-style-type: none"> 1. Wait for the projector to cool down completely before starting it up again (the projector's STAND BY indicator will turn blue)
You have connected the projector to a DVD player as the input source but the image appears broken or split in halves.	The DVD player is connected to the projector through component cables (RGB-S or RGBHV/YUV2) and you have set it to progressive scan.	Disable the progress scanning function on the DVD player.
The picture looks dim	<ol style="list-style-type: none"> 1. The image brightness, contrast, color and tint might need proper adjustment. 2. The lamp is due for replacement. 	<ol style="list-style-type: none"> 1. Adjust the image brightness, contrast, color and tint. 2. Replace the projector lamp.

Problem	Possible cause	Solution
The remote control does not operate normally	<ol style="list-style-type: none"> 1. The battery might have run out 2. You might have inserted the batteries in the wrong orientations 3. You may be operating the remote control too far away from the projector's IR sensor or exceeded the maximum angle of signal reception ; there might be an obstacle between the projector and the remote control or there might be a source of intense light near the IR receiver. 4. Ø 3.5mm A wired remote connector might be connected to the projector's 3.5mm port. 5. The remote control's address is not consistent with the projector's address. 	<ol style="list-style-type: none"> 1. Replace new batteries 2. Make sure the batteries are inserted in the right orientation. 3. Adjust the distance/angle between the projector and the remote control and try again; if there are obstacles between the projector and the remote or source of intense light near the IR sensor resolve these situations and try again. 4. Remove the wired remote cable or operate the projector using wired remote. 5. Press the OK button on the remote control followed by the Address button until the panel of the remote control flashes once (approximately 5 seconds) and try again.
You are able to turn on the projector and access the OSD Menu but no picture appears.	<ol style="list-style-type: none"> 1. The projector may not be turned on properly or you have not selected the correct input source. 2. You might not have connected the source device correctly or the source might not be connected to the projector at all. 	<ol style="list-style-type: none"> 1. Make sure the projector is turned on properly and select the correct input source. 2. Check the connection between the projector and the input device.
The image is too bright or the bright areas are blurry	The contrast might have been set too high.	Lower contrast settings.
The image appears washed out or the dark areas appear too bright	The image brightness might have been set too high.	Lower brightness settings.
The image is blurry	<ol style="list-style-type: none"> 1. The lens may not be in focus. 2. The temperature or humidity of the projector's working environment may have changed in mid operation (i.e. going from cold to warm or dry to humid), leading to condensation of moisture inside the projector. 	<ol style="list-style-type: none"> 1. Adjust Lines focus. 2. Turn of the projector first and wait for the moisture in the projector to evaporate.
The color of the image looks pale	The input signal type (RGBHV/YUV2) might not have been connected properly	Check to make sure that the connections between the projector and the input device are correct.
The image flashes occasionally	<ol style="list-style-type: none"> 1. The cables might not have been properly connected or the input device itself may be faulty. 2. If the problem persists, it may also mean the lamp might be faulty. 	<ol style="list-style-type: none"> 1. Make sure the connector and the input device have been properly connected; check to see if the input device is in normal working order. 2. Replace the projector lamp.
The colors of the projected image are out of place (i.e. displaying red as blue)	The G/Y, R/Pr, B/Pb cables from the input might have been incorrectly connected to the input.	Please make sure the input source has been correctly connected to the projector.
The noise from the cooling fan suddenly grew louder	The temperature inside the projector might have risen.	When the temperature inside the projector rises, the cooling fan will operate at a higher speed to discharge the internal heat more rapidly.
The LED indicator on the projector's front panel is blinking in red	The lamp or the cooling fan could be faulty.	Refer to the definition of page 24: 4.4 Status lights of LED
<ol style="list-style-type: none"> 1. During projection, the lamp suddenly goes off and the picture disappears. 2.The lamp does not turn on even when the projector has been turned on. 	The lamp might have been damaged; check the LED indicator on the rear panel of the projector and see if it is blinking in red.	The lamp has reached the end of its service life; please replace it.

15. PROJECTOR SPECIFICATION

15.1 Specifications

Description	Specifications
Projector type	single-chip DLP projector
Technology	0.96" DMD
Color Wheel	6S standard (RGBYCW)
Resolution	WUXGA 1920x1200
Brightness*	10000 ANSI lumen
Brightness (eco-mode)*	7500 lumens
Contrast ratio	1250 : 1
Brightness uniformity ANSI	85%
Aspect Ratio	16:10
Lens type	J lens
Lens range	R9832762: 2.4-4.0:1 R9832760: 1.85-2.4:1 R9832761: 1.56-1.85:1 R9832763: 0.84-1.03:1
Horizontal Lens Shift Range	R9832762: ±30% R9832760: ±30% R9832761: ±30% R9832763: ±25%
Vertical Lens Shift Range	R9832762: ±100% R9832760: ±100% R9832761: ±100% R9832763: ±75%
Color correction	Yes
Lamps	2x465W Ushio
Lamp life time	Up to 1500 hours(full power), up to 2000 hours (eco mode)
Transport with lamp	Yes
Sealed DLP™ core	yes
Optical dowser	yes
Advance Picture in Picture	yes
Orientation	table - ceiling
Integrated web server	yes
Keystone Correction	yes
Ease of Use	Simplified OSD menu + Remote control
Inputs	5 BNC, VGA, HDMI-1, HDMI-2
Input Resolutions	up to WUXGA (1920x1200) 60Hz
Software tools	Projection Toolset
Control	IR; RS232; RJ45
Network connection	10/100 Base-T, RJ-45
Power requirements	100 - 240V / 50 - 60 Hz
Power consumption	1180W@110VAC; 1115W@220VAC
Power consumption in ECO mode	910W@110VAC; 870W@220VAC
Power consumption in standby mode	< 2W
Noise level Bright mode (typical at 25°C/77°F)	45 dBA
Noise level ECO mode (typical at 25°C/77°F)	Typical: 40 dBA
Operational ambient temperature	0-40°C or 32-104°F
Operating humidity	0-90%
Dimensions (WxLxH)	670x530x285mm
Weight	33kg
Shipping Dimensions	829x 709x 437mm
Shipping Weight from Factory	41.5kg
Certifications	CB test certificate US emc US safety CE emc and safety CCC emc and Safety
Warranty	3 years standard warranty**

* Measurement, measuring conditions, and method of notation all comply with ISO 21118 international standards.

**Warranty and service conditions can differ from region to region. Contact your local sales or service representative for more details.

15.2 STANDARD SOURCE FILES

Signal Type	Resolution	Frame Rate	3RCA		VGA	HD15-YUV	HDMI			
			YPrPb	5BNC			YPrPb	YUV	10Bit - YUV	12Bit - YUV
PC	640×480	59.94	x	x			x			
	640×480	74.99	x	x			x			
	640×480	85	x	x			x			
	800×600	60.32	x	x			x			
	800×600	75	x	x			x			
	800×600	85.06	x	x			x			
	848×480	47.95	x	x			x			
	848×480	59.94	x	x			x			
	1024×768	60	x	x			x			
	1024×768	75	x	x			x			
	1024×768	85	x	x			x			
	1280×720	47.95	x	x			x			
	1280×1024	60.02	x	x			x			
	1280×1024	75.02	x	x			x			
	1280×1024	85.02	x	x			x			
	1400×1050	60	x	x			x			
	1600×1200	60	x	x			x			
	1920×1080	47.95	x	x			x			
	1680×1050	59.94	x	x			x			
1920×1200	50	x	x			x				
1920×1200 RB	59.94	x	x			x				
1920×1200 RB	60	x	x			x				
Apple Mac	640×480	66.59			x		x			
	832×624	74.54			x		x			
SECAM	SECAM (M)	50								
SDTV	RGBS	50								
	1440x480i	60					x	x	x	x
	1440x576i	50					x	x	x	x
	480i	59.94	x							
	576i	50	x							
EDTV	480p	59.94	x	x	x	x	x	x	x	x
	576p	50	x	x	x	x	x	x	x	x
HDTV	1035i	60	x	x	x	x	x	x	x	x
	1080i	50	x	x	x	x	x	x	x	x
	1080i (Aus)	50	x	x	x	x	x	x	x	x
	1080i	59.94	x	x	x	x	x	x	x	x
	1080i	60	x	x	x	x	x	x	x	x
	720p	50	x	x	x	x	x	x	x	x
	720p	59.94	x	x	x	x	x	x	x	x
	720p	60	x	x	x	x	x	x	x	x
	1080p	23.98	x	x	x	x	x	x	x	x
	1080p	24	x	x	x	x	x	x	x	x
	1080p	25	x	x	x	x	x	x	x	x
	1080p	29.97	x	x	x	x	x	x	x	x
	1080p	30	x	x	x	x	x	x	x	x
	1080p	50	x	x	x	x	x	x	x	x
	1080p	59.94	x	x	x	x	x	x	x	x
1080p	60	x	x	x	x	x	x	x	x	

15.3 Dimension

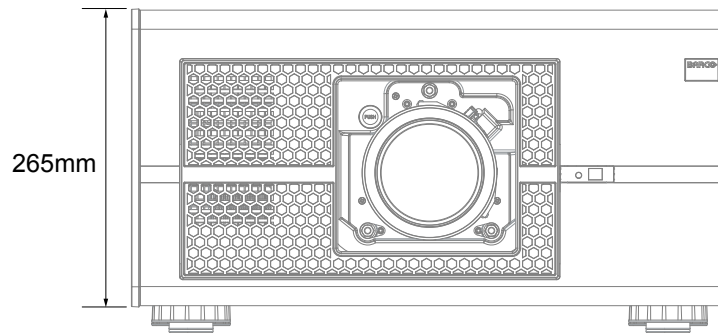
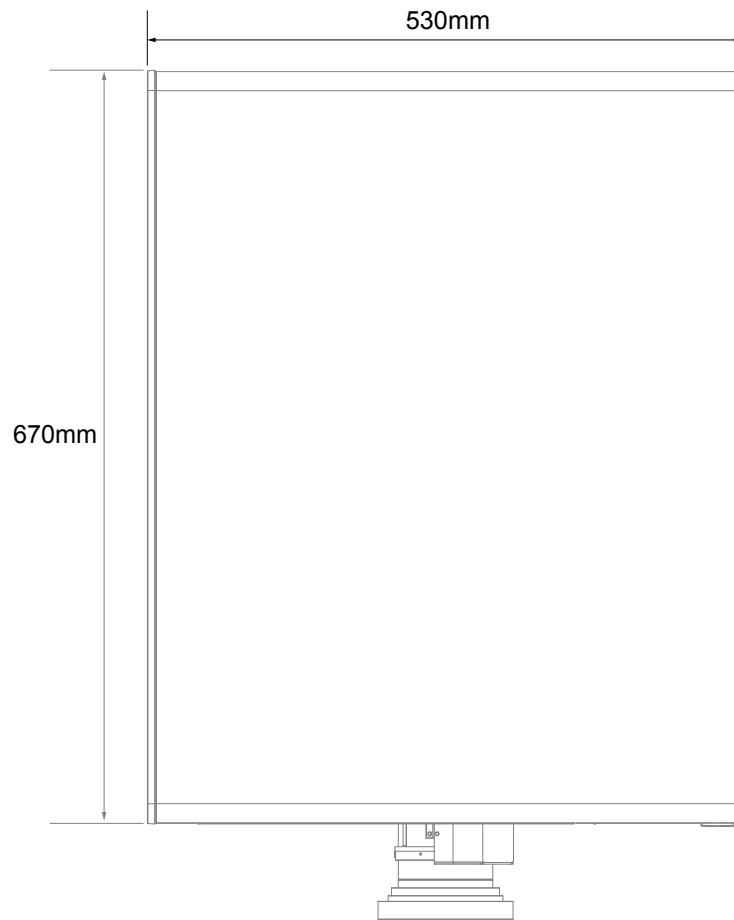

16. ENVIRONMENTAL INFORMATION

16.1 Disposal information

Disposal Information

Waste Electrical and Electronic Equipment



This symbol on the product indicates that, under the European Directive 2002/96/EC governing waste from electrical and electronic equipment, this product must not be disposed of with other municipal waste. Please dispose of your waste equipment by handing it over to a designated collection point for the recycling of waste electrical and electronic equipment. To prevent possible harm to the environment or human health from uncontrolled waste disposal, please separate these items from other types of waste and recycle them responsibly to promote the sustainable reuse of material resources.

For more information about recycling of this product, please contact your local city office or your municipal waste disposal service. For details, please visit the Barco website at: <http://www.barco.com/en/AboutBarco/weee>

Disposal of batteries in the product



This product contains batteries covered by the Directive 2006/66/EC which must be collected and disposed of separately from municipal waste.

If the battery contains more than the specified values of lead (Pb), mercury (Hg) or cadmium (Cd), these chemical symbols will appear below the crossed-out wheeled bin symbol.

By participating in separate collection of batteries, you will help to ensure proper disposal and to prevent potential negative effects on the environment and human health.

Mercury Notice



This Barco product consists of materials that may contain mercury, which must be recycled or disposed of in accordance with local, state, or country laws:

Within this system, the lamp in the projector contains mercury.

16.2 Rohs compliance

Turkey RoHS compliance



Türkiye Cumhuriyeti: EEE Yönetmeliğine Uygundur.

[Republic of Turkey: In conformity with the EEE Regulation]

中国大陆 RoHS (Information for China ROHS compliance)

根据中国大陆《电子信息产品污染控制管理办法》(也称为中国大陆 RoHS)·以下部份列出了本产品中可能包含的有毒有害物质或元素的名称和含量。



Table of toxic and hazardous substances/elements and their content, as required by China's management methods for controlling pollution by electronic information products

本产品中包含的有毒有害物质/成分的名称和含量。

产品中有害有毒物质或元素的名称及含量列表

依据中国政府针对“电子信息产品污染控制管理办法”为控制和减少电子信息产品废弃后对环境造成的污染，促进生产和销售低污染电子信息产品，保护环境和人体健康，仅提供有关本产品可能含有有毒及有害物质如后：

部件名称	有害有毒物质或元素						
	铅 (Pb)	汞 (Hg)	镉 (Cd)	六价铬 (Cr(VI))	多溴联苯 (PBB)	多溴二苯醚 (PBDE)	
光机引擎(铝或铝镁合金)	X	○	○	○	○	○	
镜头	X	○	○	○	○	○	
灯泡	X	X	○	○	○	○	
点灯器	X	○	○	○	○	○	
弹片(快削磷铜)	X	○	○	○	○	○	
风扇组件	X	○	○	○	○	○	
灯泡盖保护开关	○	○	X	○	○	○	
温度开关	○	○	X	○	○	○	
基板组件	X	○	○	○	○	○	
缆线,线材	X	○	○	○	○	○	
电源线	X	○	○	○	○	○	
电源插座组件	X	○	○	○	○	○	
金属件(快削磷铜,铜钉等)	X	○	○	○	○	○	
遥控器	X	○	○	○	○	○	

○：表示该有毒有害物质在该部件所有均质材料中的含量均在SJ/T11363-2006标准规定的限量要求以下。

×：表示该有毒有害物质至少在该部件的某一均质材料中的含量超出SJ/T11363-2006标准规定的限量要求。

备注：鉴于欧盟与中国对于RoHS的不同规定，本投影机产品符合欧盟RoHS指令(电气、电子设备中限制使用某些有害物质指令)，本表中标有“X”的所有部件均为欧盟ROHS指令所允许例外的部件。

16.3 Production address

Factories

Barco nv Entertainment Division

Noordlaan 5, B-8520 Kurne

Phone: +32 56.36.82.11

Fax: +32 56.36.883.86

Support: www.barco.com/esupport

Visit us at the web: www.barco.com

